



INDOOR ELECTRIC GRILL

OPERATING INSTRUCTIONS

EB-DLC10

Always follow basic safety precautions when using electrical appliances.
Read all instructions carefully.
Please keep this instruction book at hand for easy reference.

INDEX

IMPORTANT SAFEGUARDS	2
PARTS NAMES	5
REPLACEMENT PARTS.....	5
HOW TO USE.....	6
SAFETY MECHANISM.....	7
RECIPES	
Steaks with Horseradish Sauce.....	8
Sweet and Sour Marinated Kabobs.....	8
Grilled Spicy Prawns.....	8
Salmon Steaks with Fruit Salsa.....	9
Bruschetta.....	9
CLEANING AND MAINTENANCE.....	10
TROUBLESHOOTING GUIDE.....	11
SPECIFICATIONS.....	11

IMPORTANT SAFEGUARDS

BASIC SAFETY PRECAUTIONS SHOULD ALWAYS BE FOLLOWED WHEN USING ELECTRICAL APPLIANCES, INCLUDING THE FOLLOWING:

1. Read all instructions thoroughly.
2. Avoid touching hot surfaces. The handles and knobs are provided for your safety and protection.
3. To prevent hazardous operation or electric shock, do not immerse power cord or parts of the power cord, power plug or appliance (except drip tray) in water or other liquids.
4. Close supervision is necessary when the appliance is used by or near children.
5. Unplug from outlet when not in use and before cleaning. Allow the appliance to cool before adding or removing parts, and before cleaning the appliance. Make sure appliance is OFF when not in use, before putting on or taking off parts, and before cleaning.
6. Do not leave the appliance unattended when in use.
7. Do not use or operate the appliance with a damaged cord or plug. If the appliance malfunctions or has been damaged in any manner, unplug the appliance and return it to the nearest authorized service facility or dealer for examination, repair or adjustment.
8. Do not use outdoors.
9. The use of accessories or attachments not recommended by the appliance manufacturer may be hazardous or may cause malfunction.
10. Keep the power cord away from hot surfaces and do not let the cord hang over the edge of tables or counters.
11. Do not place the appliance on or near a heated surface such as a gas or electric stove, or in a heated oven.
12. Always use the appliance on a dry, level surface.
13. Always use extreme caution when moving appliances containing hot contents or liquids.
14. Plug the cord into a household electrical outlet. The plug to the appliance should be attached first before plugging the cord into a wall outlet. To disconnect, turn the power control to OFF. Then remove the plug from wall outlet.
15. Do not use the appliance for other than intended or specified purposes.
16. Do not operate in the presence of explosive and/or flammable fumes.
17. To reduce the risk of fire and personal injury, always use with the metal drip pan properly placed.

SAVE THESE INSTRUCTIONS

THIS APPLIANCE IS FOR HOUSEHOLD USE ONLY.

This appliance is supplied with a short power cord to reduce the risk of becoming entangled in or tripping over. Extension cords may be used if care is exercised in their use. If an extension cord is used, the marked electrical rating of the cord should be at least as great as the electrical rating of the appliance, and a longer cord should be arranged so that it will not drape over the countertop or tabletop where it can be pulled on by children or tripped over unintentionally.

This appliance has a polarized plug (one blade is wider than the other). To reduce the risk of electric shock, this plug was designed to fit into a polarized outlet in only one direction. If the plug does not fit fully into the outlet, do not attempt to force it or modify it in any way. Simply reverse the plug and insert. If it still does not fit, contact a qualified electrician.

To avoid circuit overload, do not operate another high wattage appliance on the same circuit.

● These WARNINGS and CAUTIONS are intended to protect you and others from personal injury and household damage. To ensure safe operation, please follow carefully.

 **WARNINGS** Indicates risk of serious injury. ※1

 **CAUTIONS** Indicates risk of injury or property damage if mishandled. ※2 ※3

※1 Serious injury includes loss of eyesight, burns (high and low temperature), electric shock, bone fractures, toxic reactions as well as other injuries severe enough to require medical care or extended hospitalization.

※2 Injury indicates physical damage, burns or electric shock not severe enough to require medical care or extended hospitalization.













 **CAUTIONS** Indicates a warning or caution. A specific caution is indicated inside or near the triangle by sentences or illustrations.

 **PROHIBITED** Indicates a prohibited operation. A specific prohibited operation is indicated inside or near the circle by sentences or illustrations.

 **INSTRUCTIONS** Indicates a requirement or instruction that must be followed. A specific instruction is indicated inside or near the circle by sentences or illustrations.

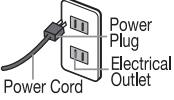
※3 Property damage indicates material damage towards a home, furniture, or pets and animals.











WARNINGS

 Do not use a power source other than 120V AC. Use of any other power supply voltage may cause fire or electric shock.	 Do not damage the Power Cord. Do not bend, pull, twist, fold, or attempt to modify the Power Cord. Do not place it on or near high temperature surfaces or appliances, under heavy items or between objects. A damaged Power Cord can cause fire or electric shock.
 Do not modify the product. Only a repair technician may disassemble or repair this unit. Attempting to do so may cause fire, electric shock or injury. Make any repair inquiries to Zojirushi customer service.	 Insert the Power Plug completely and securely into the electrical outlet. A loosely inserted Power Plug may cause electric shock, short circuit, smoke or fire.
 Do not plug or unplug the Power Plug if your hands are wet. Doing so may cause electric shock or injury.	 Use only an electrical outlet rated at 15 amperes minimum, and do not plug other devices into the same outlet. Plugging other devices into the same outlet may cause the electrical outlet to overheat, resulting in fire.
 Do not immerse the product in water or splash water on the Receptacle. Doing so may cause short circuit or electric shock.	 Stop using immediately if you notice any of the following symptoms indicating a malfunction or breakdown. Continued use of the product may cause smoke, fire, electric shock or injury. <ul style="list-style-type: none"> • The Power Plug or Power Cord has become very hot. • The Power Cord is deeply damaged or deformed. • The electricity turns on and off when the Power Cord is touched or moved. • There is a burning smell. • You feel a tingle or slight electrical shock. • The product does not operate even though the Temperature Control Dial is turned on. • The Operation Light does not turn off even though the Temperature Control Dial is turned to OFF. If any of the above occurs, unplug the product immediately and return to the store where you purchased it for check-ups and/or repairs.
 Do not use the product if the Power Plug or Power Cord is damaged or if the Power Plug is loosely inserted into the electrical outlet. Doing so may cause electric shock, short circuit or fire. 	
 Do not attach pins on the Temperature Control Plug or soil it. Doing so may cause electric shock, short circuit or fire.	
 Do not allow children to use the product unsupervised. Keep it out of the reach of infants. May cause burns, electric shock or injury. Pay particular attention to prevent burns and injury by the plate's edges.	
 Keep children from licking the Temperature Control Plug. Pay particular attention with infants. Doing so may cause electric shock or injury.	

● The illustrations used in this Operating Instructions may vary from the actual product you have purchased.

IMPORTANT SAFEGUARDS (cont.)

⚠ CAUTIONS

 <p>Do not touch hot surfaces during or immediately after use. Touching hot surfaces may cause burns.</p>	 <p>Unplug the Power Plug from the outlet when the product is not in use. Leaving the Power Plug in an outlet may cause the insulation to become damaged, resulting in electric shock, short circuit or fire.</p>
 <p>Do not use in dangerous locations such as unstable places, on table coverings that are vulnerable to heat, near an open flame or flammable substances, or in slippery places. Doing so may cause fire.</p>	 <p>Always unplug the product by holding the Power Plug, not by pulling the Power Cord. Pulling the Power Cord to unplug the product may cause electric shock, short circuit or fire.</p>
 <p>Do not heat cans or jars of food directly. Doing so may cause burns or injury as the can or jar may break.</p>	 <p>Please allow the product to cool down before cleaning. Touching hot areas may cause burns.</p>
 <p>Do not use the product near walls or furniture. Steam or heat may damage, discolor or deform walls or furniture.</p>	 <p>During preheating or cooking, move birds and small animals that may be sensitive to smoke or smells to other rooms, and open windows or turn on exhaust fans.</p>
 <p>Do not use other Temperature Control Plugs than the one provided. Do not use the Temperature Control Plug for other appliances. Doing so may cause malfunction or fire.</p>	 <p>If the Temperature Control Plug is damaged, it must be replaced by an appropriate cord or assembly made available by the manufacturer or its service agent.</p>

This product is not intended for use by persons (including children) with reduced physical, sensory or mental capabilities, or lack of experience and knowledge, unless they have been given supervision or instruction concerning use of the product by a person supervised to ensure that they do not play with the product.

IMPORTANT

■ Plate and its Nonstick Coating

Please follow these instructions to ensure extended use of the Plate and for the protection of the nonstick coating:

- Do not use metal spatulas. Doing so may damage the surface.
- Do not scratch the Plate with sharp objects such as knives or forks.
- Do not preheat the Plate for an extended period of time. Do not use the Plate directly on the stovetop.
- Do not use a thinner, benzene, abrasive cleaners and brushes (nylon/metal), chlorine bleach or anything that may damage the surface of the product. Doing so may cause deformation, discoloration or scarring of the product.
- Always clean the surface and the bottom of the Plate thoroughly after use. Acid (vinegar) or salt contents (sauce, soy sauce or salt) may cause corrosion or the product may not perform well.
- Do not use detergents other than mild kitchen detergent such as chlorine based alkaline detergents or those containing acidic ingredients. Doing so may cause corrosion.

REMARKS: The nonstick coating may wear out with use.

The nonstick coating may eventually discolor or peel off. This will not affect the cooking performance or sanitary properties, and is harmless to your health. If concerned with the peeling of the nonstick coating, please replace the Plate by purchasing a new one. → pg.5

■ Temperature Control Plug

- Only use the Temperature Control Plug provided.
- Always remove the Temperature Control Plug from the Plate after use.
- Never disassemble the Temperature Control Plug.
- Always clean the Probe and Receptacle of dust, soil or foods.
- **Do not bang, drop or handle the Temperature Control Plug roughly. Do not move the Temperature Control Plug up and down when plugging in or unplugging.**
- Clean any grease from the Release Buttons after use.

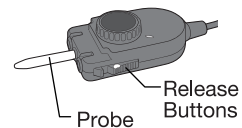

■ Use and Care

- Do not use this product for other than grilling foods indoors.
- Handle the product gently; otherwise it may cause malfunction or breakdown.
- Do not use the Plate on a gas or electric stovetop burner. Doing so may cause the nonstick coating to peel off, corrode, or cause the Plate to deform or discolor.
- **Do not use the Drip Tray soiled.**
- **Do not use on top of items such as newspapers that may obstruct the air flow beneath the Base. Do not use on surfaces that are vulnerable to heat such as carpets, cushions, tatami mats or tablecloths. Doing so may cause fire, deform the Base, or burn the surface.**
- **Do not use on top of glass surfaces such as a glass table. Doing so may cause the glass to break from the heat.**

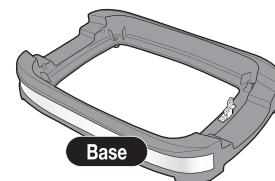

PARTS NAMES

Plate

● Do not bang or drop the Plate or handle roughly.

● Do not use metal utensils. Doing so may damage the Plate.

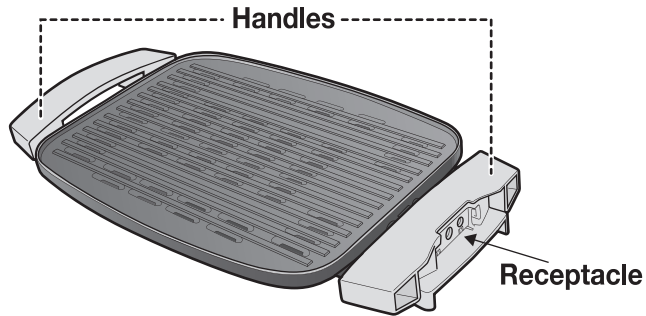

Temperature Control Plug

● Please remove the twist tie holding the Power Cord before use.
 ● Do not use the Power Cord bundled up. Doing so may cause the Power Cord to become excessively hot, resulting in malfunction.

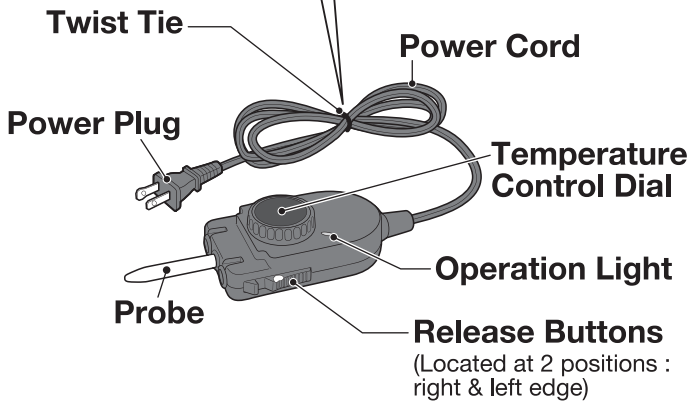

Drip Tray

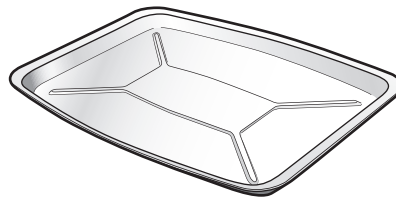

Base

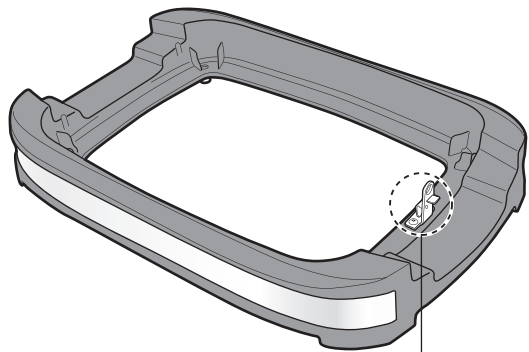

REPLACEMENT PARTS

- Please replace damaged parts for optimum performance.
- When replacing parts, please record the model number and part name beforehand. Then contact either the store where you purchased the product or Zojirushi Customer Service.

Zojirushi Customer Service
 1-800-733-6270
 www.zojirushi.com

Parts Names	Parts Number
Plate	BX138801G-00
Temperature Control Plug	BX138804A-00

HOW TO USE

1 Preparation

① Place the Drip Tray in the Base.

② Set up the Plate on the Base.

- Do not use the product without the Drip Tray. Doing so may scorch the table or surface, or cause burns.
- Make sure that the Drip Tray and Plate are level, and not leaning.
- The Plate will fit onto the Base only one way. Make sure to set it up correctly.
- Do not insert the Temperature Control Plug in the Plate before placing the Plate on the Base. Doing so may cause malfunction.

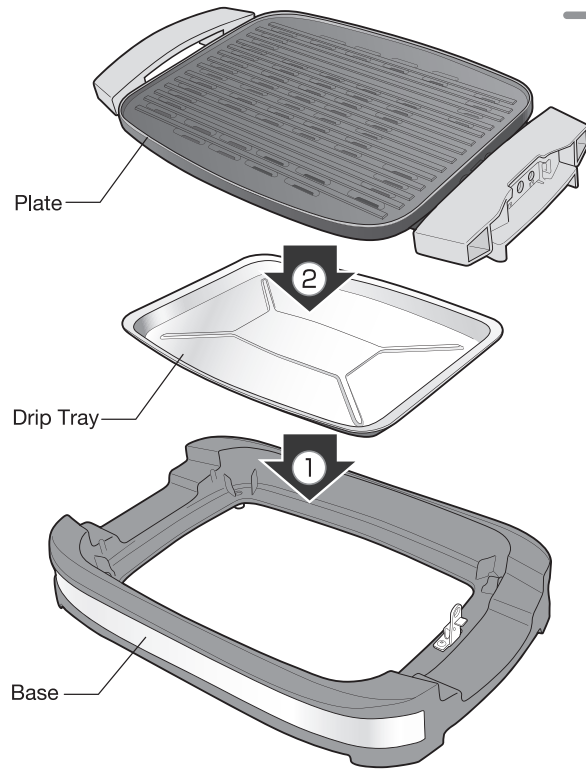

2 Insert the Temperature Control Plug

① Firmly insert the Temperature Control Plug to the Plate.

② Then plug in the Power Plug to an electrical outlet.

- ◆ Do not use other Temperature Control Plugs than the one provided. Do not use the Temperature Control Plug for other appliances.
- ◆ Insert the Temperature Control Plug completely until the white crescent marks on both Release Buttons are completely visible. The Plate may not heat up properly if the Temperature Control Plug is not inserted completely. Incorrectly inserting the Temperature Control Plug may also cause accidents or malfunctions due to abnormal heat generation.

- Make sure OFF aligns with the Operation Light.

○ Correctly Inserted :

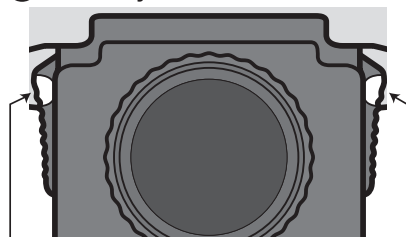

The white crescent marks on both Release Buttons are completely visible.

✗ Incorrectly Inserted :

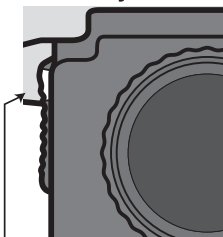

Mark is hidden.

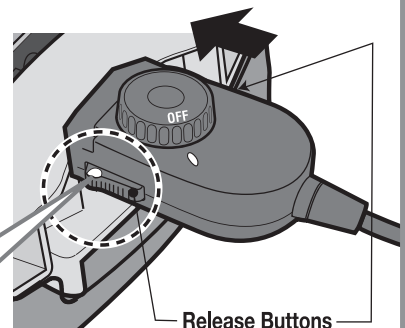

- To remove the Temperature Control Plug, pinch both Release Buttons and pull the Plug away.

- This product is for grilling foods only. Do not use for other than intended purposes.
- Wipe the Plate clean before use.

3 Preheat and Cook

- ① To begin preheating, turn the Temperature Control Dial so that HI aligns with the Operation Light. The Operation Light turns on and the Plate will begin to heat up.

Approximate time for preheating	Approx. 6 min
---------------------------------	---------------

- ② The Operation Light will turn off when preheating completes. Turn the Temperature Control Dial so that the desired heat strength aligns with the Operation Light, and begin cooking.

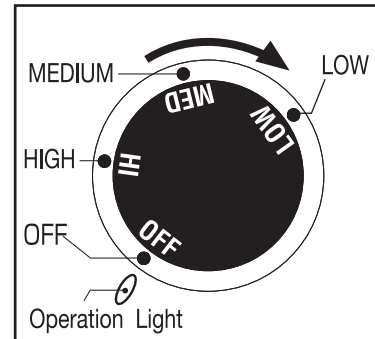

■ Temperature Guide ■

HIGH	For preheating and cooking
MEDIUM	If foods burn, adjust the temperature between HI and MED.
LOW	Keep warm

- To keep food warm, set the dial to LOW.
- The product may make a creaking sound, but this is normal and does not indicate a malfunction.
- The Operation Light will turn on and off during cooking. This indicates that the temperature is being controlled and not a malfunction.
- There may be some smoke or odor the first time the product is used, which is normal.

4 After Use

- ① Turn the Temperature Control Dial to OFF (align with the Operation Light), then unplug the Power Plug from the electrical outlet.
- ② Wipe off burnt on foods with a soft paper or cloth while the Plate is warm.
- ③ Allow the Plate to cool (at least 30 minutes after use), then remove the Temperature Control Plug from the Plate and clean.

- The Plate (and Receptacle), Drip Tray and the Probe on the Temperature Control Plug will be hot for a while after use. Please take caution to prevent burns.
- Do not attempt to remove the Plate while the Temperature Control Plug is still inserted. Doing so may cause malfunction or damage.

SAFETY MECHANISM

This product is equipped with the following safety features :

- The Temperature Control Plug cannot be inserted if the Drip Tray and Plate are not properly placed.
- The Plate cannot be removed from the Base while the Temperature Control Plug is inserted.

Never force the Temperature Control Plug in or remove the Plate forcefully as doing so may cause malfunction.

RECIPES

Take extra care while cooking as oil may splatter.

Steaks with Horseradish Sauce

Heat setting HIGH

Ingredients (2 servings)

2 sirloin steaks
[about 1-inch (2.5 cm) thick, about 1 lb. (450g)]
Salt and pepper, to taste

[Horseradish Sauce]

2 Tbsp. brandy
4 Tbsp. beef stock
3 Tbsp. heavy cream
1 Tbsp. prepared horseradish
1/2 tsp. sugar
Salt, to taste

How to cook

1. Sprinkle and press the salt and pepper onto both sides of the meat.
2. Put the sirloin steaks on the preheated Plate and cook them to the desired doneness.
3. To make the Horseradish Sauce, boil the brandy in a pan and then add all remaining ingredients. Mix the sauce until it is smooth.
4. Serve steaks with the horseradish sauce.

Sweet and Sour Marinated Kabobs

Heat setting HIGH

Ingredients (4 servings)

1/2 lb. (230 g) beef
1 large red bell pepper
1 large green bell pepper
1/4 small pineapple, peeled
8 skewers
1 tsp. cornstarch

[Marinade]

1 cup pineapple juice
1/2 cup orange juice
2 Tbsp. white vinegar
1 Tbsp. brown sugar
1 tsp. garlic, minced

How to cook

1. Prepare the marinade by mixing the ingredients.
2. Cut beef into 3/4-inch (2 cm) square cubes and put the pieces of beef in a shallow bowl made of glass or enamel. Pour half of the prepared marinade on the beef and marinate it in the refrigerator for one hour.
3. Alternately skewer the marinated beef with green and red bell peppers and pineapple cut into 3/4-inch (2 cm) square cubes. Prepare 8 skewers.
4. To make the sweet and sour sauce, add cornstarch to the remaining marinade and then boil and mix the sauce until it is smooth.
5. Put the skewered food on the preheated Plate and cook them completely, turning several times.
6. Serve with the sweet and sour sauce.

Grilled Spicy Prawns

Heat setting HIGH

Ingredients (2 to 4 servings)

8 small prawns
[Marinade]
2 Tbsp. soy sauce
1 tsp. sesame oil
1 Tbsp. cajun seasoning mix
1 Tbsp. fresh lime juice
1 tsp. fresh minced ginger
1 tsp. mustard paste

How to cook

1. Peel and devein the prawns.
2. Marinate the prawns in the marinade for 5 to 10 minutes.
3. Put the prawns on the preheated Plate and cook both sides thoroughly.
4. Serve the prawns on plates.

NOTE

The measurements used in these Recipes:

1 cup = approx. 8 oz. (240 mL)

1 Tbsp. = 0.5 oz. (15 mL)

1 tsp. = 0.2 oz. (5 mL)

■ Salmon Steaks with Fruit Salsa

Heat setting	HIGH
--------------	------

Ingredients (4 servings)

4 salmon steaks
[(about 1/2-inch (1.5 cm) thick, about 1/4 lb. (110 g)]
Salt and pepper, to taste

(Marinade)

2 Tbsp. lemon juice
2 Tbsp. lime juice
1 Tbsp. chopped fresh thyme

(Fruit Salsa)

1/2 small papaya, peeled
1/4 small pineapple, peeled
Parsley, chopped, to taste
2 Tbsp. lime juice
1 Tbsp. Sugar
Salt, to taste

How to cook

1. Sprinkle the salt and pepper onto the salmon.
2. Pour the prepared marinade over the salmon and marinate it in the refrigerator for one hour.
3. Put the salmon steaks on the preheated Plate and cook them completely, periodically basting the steaks with the marinade.
4. To make the Fruit Salsa, cut the papaya and pineapple into cubes and mix them with the remaining ingredients.
5. Serve salmon with the fruit salsa.

■ Bruschetta

Heat setting	HIGH
--------------	------

Ingredients (4 to 8 appetizer servings)

2 large red ripe tomatoes [(about 1 lb. (450 g)], diced
1/3 cup coarsely chopped fresh basil
1 Tbsp. peeled and diced onion (optional)
2 Tbsp. extra-virgin olive oil
Clove of garlic, peeled and minced
1 tsp. balsamic or red wine vinegar
Salt and pepper, to taste
8 slices diagonally cut crusty French bread
[about 3/4-inch (2 cm) thick]
Garlic salt, to taste

How to cook

1. Mix all ingredients except for the bread and garlic salt in a glass or enamel bowl, and let stand for about 30 minutes at room temperature.
2. Put the bread on the preheated Plate and brown both sides.
3. Sprinkle the garlic salt onto one side of the browned bread.
4. Dish the bread onto plates and serve with a generous amount of the sauce made in step 1.

CLEANING AND MAINTENANCE

Be sure to clean thoroughly after every use. Leaving burnt foods on the Plate may cause scorching, and will become difficult to remove.

Clean the product after it has cooled down completely except for the Plate.

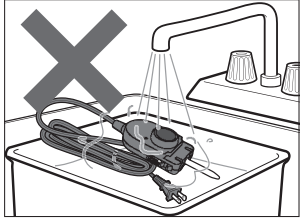
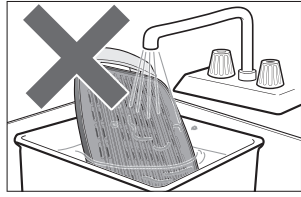
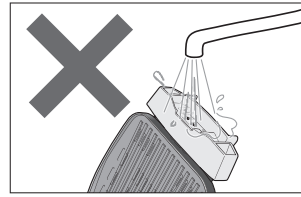
<p>Base</p>	<p>① Place mild kitchen detergent on a soft cloth and wipe. ② Wipe detergent off with a well-wrung cloth. ③ Wipe dry with a soft dry cloth.</p> <p>● Do not soak. Doing so may cause water to pool inside the double-wall.</p>	<p style="text-align: center;">CAUTION</p> <ul style="list-style-type: none"> ● Never wash the Temperature Control Plug under water. Doing so may cause malfunction.  <ul style="list-style-type: none"> ● Do not use abrasive cleaners, scouring powders, nylon or steel brushes. Doing so may cause deformation, discoloration or scratches. ● Do not use detergents other than mild kitchen detergents such as chlorine based alkaline detergents or acidic detergents. Doing so may cause corrosion. ● Do not leave or use the Plate soiled. Make sure to clean the bottom as well as the sides of the grids. Leaving the Plate soiled will not only make it difficult to clean, but will also cause uneven heating. It may also cause malfunction or fire. ● Do not use a dishwasher or a dish-dryer. Doing so may cause discoloration. ● Always clean thoroughly after using acid (vinegar) or salt contents (sauce, soy sauce or salt). Leaving them on may cause corrosion of the nonstick coating. ● Do not soak the Plate.  <ul style="list-style-type: none"> ● Do not allow water to come into contact with the Receptacle. 
<p>Drip Tray</p>	<p>① Use a mild kitchen detergent and a soft sponge to wash. ② Rinse and then wipe clean with a dry cloth.</p> <p>● Soak Drip Tray in warm water if food becomes stuck, then wash with a soft sponge.</p>	
<p>Temperature Control Plug</p>	<p>Wipe it clean with a soft dry cloth.</p>	
<p>Plate</p>	<p>① Wipe off burnt on foods with a soft paper or cloth while the Plate is warm. ② Remove the Plate from the base, then wash with a soft sponge soaked in warm water and mild kitchen detergent. ③ Wipe detergent off with a clean, well-wrung sponge and wipe dry with a soft cloth. ④ Wipe clean the Receptacle with a soft dry cloth.</p> <p>● Do not wipe the Receptacle with anything wet. ● Do not use the rough side of the sponge. ● After cleaning the Plate, wipe thoroughly with a dry cloth, set in the Base and turn the power on to allow it to dry completely. Be sure not to overheat the Plate.</p>	

TROUBLESHOOTING GUIDE

Please check the following points before calling for service.

Problems	Cause	Remedy
Temperature Control Plug (Probe) will not plug in.	● Are the Drip Tray and Plate properly set up?	Please set them correctly.
The Plate does not heat up.	● Is the Power Plug unplugged?	Insert the Power Plug securely.
	● Is the Temperature Control Plug connected correctly?	Insert the Temperature Control Plug completely until the white marks on the Release Buttons are fully visible. (See pg.6)
The food does not cook well.	● Insufficient preheating.	Start cooking after preheating completes. (See pg.7 "Approximate time for preheating")
Food is scorched.	● Is the Plate properly cleaned and maintained?	Perform Cleaning and Maintenance. (See pg.10)
Plate cannot be removed from the Base.	● Is the Temperature Control Plug still attached?	Remove the Temperature Control Plug.

SPECIFICATIONS

Model No.		EB-DLC10
Rating		AC120 V 60 Hz
Electric Consumption		1500 W
Length of the Power Cord		5'2" (1.6 m)
External Dimensions	(approx. inches)	20-3/4 × 14-1/8 × 3-5/8
	(approx. cm)	52.5 × 35.5 × 9
Weight		10 lbs. (4.5 kg)
Temperature Control		176~410 °F (80~210 °C)



www.zojirushi.com

EB-DLC ©®