



USA CAN

FRESH BREW PLUS 12-CUP COFFEE MAKER OPERATING INSTRUCTIONS

EC-YGC120

Always follow basic safety precautions when using electrical appliances.
Read all instructions carefully.
Please keep these Operating Instructions at hand for easy reference.

INDEX

IMPORTANT SAFEGUARDS	2
REPLACEMENT PARTS	5
SPECIFICATIONS	5
PARTS NAMES	6
HOW TO SET THE CLOCK	7
SOUND SIGNALS AND HOW TO CHANGE THEM	7
HOW TO ATTACH AND REMOVE EACH PART	8
HOW TO USE	9
● BREWING ICED COFFEE	14
HOW TO SET THE TIMER	16
CLEANING AND MAINTENANCE	17
● HOW TO PERFORM CITRIC ACID CLEANING	18
TROUBLESHOOTING GUIDE	19

IMPORTANT SAFEGUARDS

Be sure to follow the instructions.

To reduce the risk of fire, electric shock, and / or injury to persons, when using electrical appliances, basic safety precautions should always be followed, including the following:

1. Read all instructions.
2. Do not touch hot surfaces. Use handles or knobs. Do not close or clog the steam vent opening under any circumstances.
3. To protect against fire, electric shock and other injury to persons, do not immerse cord, plugs or the appliance in water or other liquids.
4. Close supervision is necessary when any appliance is used by or near children.
5. Unplug from outlet when either the appliance or display clock is not in use, and before cleaning. Allow to cool before adding or removing parts other than the Carafe, and before cleaning the appliance.
6. Do not operate any appliance with a damaged cord or plug, or after the appliance malfunctions or has been damaged in any manner. Return appliance to the nearest authorized service facility for examination, repair or adjustment.
7. The use of accessory attachments not recommended by the appliance manufacturer may result in fire, electric shock or other injury to persons.
8. Do not use outdoors.
9. Keep the power cord away from hot surfaces and do not let the cord hang over the edge of tables or counters.
10. Do not place on or near a hot gas or electric burner, or in a heated oven.
11. To disconnect, turn the power off by pressing the CANCEL button, then remove plug from wall outlet.
12. Do not use appliance for other than intended use.
13. To protect against electrical hazards, unplug the cord at all times before cleaning.
14. Scalding may occur if the swing basket or filter basket is removed during the brewing cycles.
15. The glass carafe is designed for use with this appliance. It must never be used on a range top.
16. Do not set the hot glass carafe on a wet or cold surface.
17. Do not use a cracked glass carafe or a glass carafe having a loose or weakened handle.
18. Do not clean the glass carafe with cleansers, steel wool pads, or other abrasive materials.



NOTE: This appliance has a polarized plug (one blade is wider than the other). To reduce the risk of electric shock, this plug is intended to fit into a polarized outlet only one way. If the plug does not fit fully into the outlet, reverse the plug. If it still does not fit, contact a qualified electrician. Do not attempt to modify the plug in any way.

SAVE THESE INSTRUCTIONS

THIS APPLIANCE IS FOR HOUSEHOLD USE ONLY.

- A. A short power-supply cord is provided to reduce risks resulting from becoming entangled in or tripping over a longer cord.
- B. Extension cords may be used if care is exercised in their use.
- C. If an extension cord is used, (1) the marked electrical rating of the extension cord should be at least as great as the electrical rating of the appliance, (2) if the appliance is of the grounded type, the extension cord should be a grounding-type 3-wire cord, and (3) the longer cord should be arranged so that it will not drape over the counter top or table top where it can be pulled on by children or tripped over.







	WARNING RISK OF FIRE OR ELECTRIC SHOCK DO NOT OPEN	
WARNING: TO REDUCE THE RISK OF FIRE OR ELECTRIC SHOCK, DO NOT REMOVE COVER (OR BOTTOM) NO USER-SERVICEABLE PARTS INSIDE REPAIRS SHOULD BE DONE BY AUTHORIZED SERVICE PERSONNEL ONLY		

	The lightning flash with arrowhead symbol, within an equilateral triangle, is intended to alert the user to the presence of uninsulated "dangerous voltage" within the product's enclosure that may be of sufficient magnitude to constitute a risk of fire or electric shock to persons.
	The exclamation point within an equilateral triangle is intended to alert the user to the presence of important operating and maintenance (servicing) instructions in this literature.



IMPORTANT SAFEGUARDS (cont.)

These WARNINGS and CAUTIONS are intended to prevent property damage or personal injury to you and others.

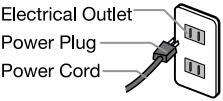
⚠ WARNINGS

 <p>Do not modify the product. Only a repair technician may disassemble or repair this unit. Attempting to do so may cause fire, electric shock or injury. Make any repair inquiries to Zojirushi Customer Service.</p>	 <p>Insert the Power Plug completely and securely into the electrical outlet. A loosely inserted Power Plug may cause electric shock, short circuit, smoke or fire.</p>
 <p>Do not immerse the product in water or splash it with water. Doing so may cause short circuit or electric shock.</p> <p>Do not allow liquid to come in contact with the Power Plug or Power Cord. Doing so may cause short circuit or electric shock.</p>	<p>Use only an electrical outlet rated at 15 amperes minimum, and do not plug other devices into the same outlet. Plugging other devices into the same outlet may cause the electrical outlet to overheat, resulting in fire.</p>
 <p>Do not plug or unplug the Power Plug if your hands are wet. Doing so may cause electric shock or injury.</p>	<p>If the blades or surface of the Power Plug become soiled, wipe them clean. A dirty Power Plug may cause fire.</p>
 <p>Do not touch the Steam Vent or bring your hands or face near the Steam Vent. Doing so may cause burns or scalding. Take special precautions with children and infants.</p>	<p>Stop using immediately if you notice any of the following symptoms indicating a malfunction or breakdown. Continued use of the product may cause smoke, fire, electric shock or injury.</p>
 <p>Do not allow children to use the product unsupervised. Keep it out of the reach of infants. Children are at risk of burns, electric shock or injury.</p>	<ul style="list-style-type: none"> • The Power Plug or Power Cord has become very hot. • The Power Cord is deeply damaged or deformed. • There is a burning smell. • Some part of the product is cracked, unstable or loose. • The electricity turns on and off when the Power Cord is touched or moved. • The product does not operate even though it is turned on. • Water leaks from the Main Body. • Water or steam leaks from parts of the Main Body other than the Steam Vent. • The Main Body is deformed or has become very hot. <p>If any of the above occurs, unplug the product immediately and return to Zojirushi Customer Service for check-ups and/or repairs.</p>
<p>Do not use a power source other than 120 V AC. Use of any other power supply voltage may cause fire or electric shock.</p>	<p>This appliance is not intended for use by persons (including children) with reduced physical, sensory or mental capabilities, or lack of experience and knowledge, unless they have been given supervision or instruction concerning use of the appliance by a person responsible for their safety. Children should be supervised to ensure that they do not play with the appliance.</p>
<p>Do not use this product without the Glass Carafe. Doing so may cause scalding.</p>	
<p>Do not use the product if the Power Plug or Power Cord is damaged or if the Power Plug is loosely inserted into the electrical outlet.</p>  <p>Doing so may cause electric shock, short circuit or fire.</p>	
<p>Do not damage the Power Cord. Do not bend, pull, twist, fold, or attempt to modify the Power Cord. Do not place it on or near high temperature surfaces or appliances, under heavy items or between objects. A damaged Power Cord can cause fire or electric shock.</p>	



⚠ CAUTIONS

 <p>Do not touch hot surfaces such as the Swing Basket, Glass Carafe (except the Handle), or Keep Warm Plate while you are using the product, or for a while after you have used the product. Touching hot surfaces may cause burns or injury.</p>	 <p>Do not use the product on surfaces that are vulnerable to heat. Doing so may cause fire.</p> <p>Do not use the product on unstable surfaces. Doing so may cause scalding or injury.</p> <p>Do not remove the Glass Carafe while brewing. Doing so may cause scalding.</p>
--	---

● The illustrations used in these Operating Instructions may vary from the actual product you have purchased.

IMPORTANT SAFEGUARDS (cont.)

CAUTIONS

 <p>Do not use the product near walls or furniture. Steam or heat may damage, discolor or deform walls or furniture.</p> <p>Do not move the product when the Glass Carafe is in place. Doing so may cause scalding or other injury.</p> <p>Do not use near an open flame. Doing so may cause fire.</p> <p>Do not refill the Water Tank while coffee is brewing. Coffee may overflow and cause scalding.</p> <p>After the Water Tank is attached to the Main Body, do not move or remove it from the Main Body. Doing so may cause scalding, water leaks, or malfunction.</p>	 <p>Unplug the Power Plug from the electrical outlet when the product is not in use. Leaving the Power Plug in an outlet may cause the insulation to become damaged, resulting in electric shock, short circuit or fire.</p>
	 <p>Please allow the product to cool down before cleaning. Touching hot surfaces may cause burns.</p>
	<p>Always unplug the product by holding the Power Plug, not by pulling the Power Cord. Pulling the Power Cord to unplug the product may cause electric shock, short circuit or fire.</p>
	<p>If the Power Cord is damaged, it must be replaced by the manufacturer, its service agent or similarly qualified persons to avoid hazards.</p>

IMPORTANT

<p>■ Do not heat the Glass Carafe in a microwave oven or place it on top of direct flames (such as a gas stove top), or electric or induction heating (IH) cookers. Doing so may cause smoke or fire, or cracks in the Carafe. The Handle of the Carafe may deform or sparks may be emitted from the metal parts.</p>	<p>■ Unplug the Power Plug from the electrical outlet soon after use. Leaving the Power Plug continuously inserted in an electrical outlet for long periods may cause a malfunction, resulting in overheating or smoke.</p>
<p>■ Do not fill the Water Tank with anything other than water, such as milk, alcohol, coffee, or hot water. Doing so may cause malfunction.</p>	<p>■ Do not soak the Glass Carafe in water, splash it with water or place it on a wet surface while it is still hot. If the Carafe is damaged, it could easily break. If it does, please be careful not to cut your hands with broken glass.</p>
<p>■ Do not use the product where its steam may come into contact with other electrical appliances. The steam may cause fire, malfunction, discoloration or deformation to other electrical appliances.</p>	<p>■ Do not open the Swing Basket while you are using the product. Doing so may cause scalding.</p>
<p>■ When brewing coffee consecutively, wait at least 5 minutes after the START light turns off. Be careful when adding water or moving the product while it is still hot as steam or hot water may come out from the Shower Head and may cause scalding.</p>	<p>■ Do not directly touch the Basket Coffee Filter immediately after brewing is finished. Doing so may cause scalding.</p>
<p>■ Do not use or place the product on wet surfaces. Doing so may cause electric shock.</p>	<p>■ Do not remove the Water Tank while you are using the product.</p>
<p>■ Do not drop the Glass Carafe or hit it against a hard surface or object. It may break the glass and cause injury.</p>	<p>■ Do not use the product in outdoor locations. Doing so may cause malfunction.</p>
<p>■ Do not operate the product without filling the Water Tank with water (except during KEEP WARM mode). It may cause malfunction.</p>	<p>■ Make sure that the entire product is placed squarely on a table and does not protrude. Doing so may cause scalding or other injury.</p>
<p>■ Be sure to carry the Main Body only by the Grips on the side and not by other parts.</p>	<p>■ Do not put your hand under the Swing Basket while you are using the product, or for a while after you have used the product. Hot water may drip and cause scalding.</p>
	<p>■ Do not use more than 12 leveled Measuring Spoons (approx. 2.16 oz. / 61.2 g) of ground coffee. Doing so may cause the coffee to overflow and cause scalding.</p>

IMPORTANT (cont.)

<p>■ Do not leave the Water Tank filled with water. Doing so may cause malfunction, discoloration, odor, or deterioration in water quality.</p>	<p>■ This appliance is intended for household use and similar applications listed below:</p> <ul style="list-style-type: none"> • Staff (employee) kitchen areas in shops, offices and other working environments. ※ This appliance is not intended for use by many unspecified people for a long period of time. <p>This appliance must not be used in the following areas:</p> <ul style="list-style-type: none"> • Farm houses. • By clients in hotels, motels and other residential type environments. • Bed and breakfast type environments.
<p>■ Do not use finely-ground coffee. Doing so may cause the coffee to overflow and cause scalding.</p>	
<p>■ Do not use the product on a carpet or fabric tablecloth. The carpet or tablecloth may be stained if the coffee splashes out.</p>	

REPLACEMENT PARTS

- Replacement parts may be available for an additional charge. Please replace damaged parts only with new parts.
- When replacing parts, please note the model number and part name beforehand. Then contact either the store where you purchased the product or Zojirushi Customer Service.

Zojirushi Customer Service
1-800-733-6270 www.zojirushi.com

Parts Names	Parts Number
Glass Carafe	JUGECYGC-XB
Measuring Spoon	BX155054L-01
Citric Acid Cleaner for Electric Water Boilers (1 oz. / 30 g x 4 packets)	CD-K03E-JU

- The Glass Carafe (sold as a replacement part) does not include the Carafe Lid and Ice Basket.

SPECIFICATIONS

Model No.	EC-YGC120	
Rating	AC 120 V 60 Hz	
Electric Consumption	1320 W	
Capacity	Max. 61 oz. (1.8 L)	
Coffee Brewing System	Automatic Drip	
Length of the Power Cord	2' 11" (0.9 m)	
External Dimensions	(approx. inches)	11-1/8 (W) × 8 (D) × 14-7/8 (H)
	(approx. cm)	28 (W) × 20 (D) × 37.5 (H)
Weight	Approx. 10 lbs. (4.3 kg)	

- External dimensions are measured without the Handle of the Glass Carafe.
- In high altitudes or severely cold areas, the product may not perform as specified. Avoid using the product in such areas or in other extreme conditions.
- This product is not suitable for use in countries or regions with different power supply voltages or frequencies.

PARTS NAMES

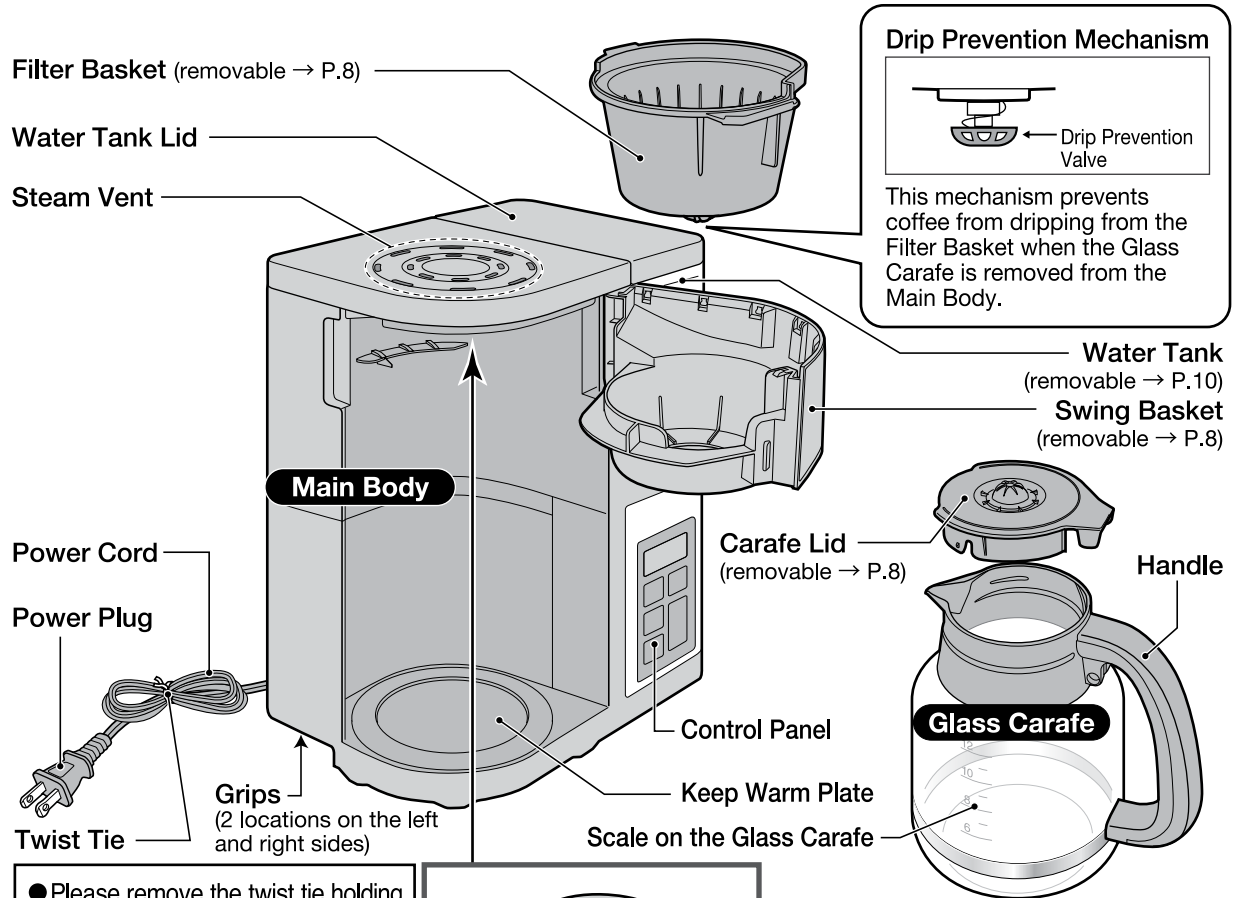

Drip Prevention Mechanism

Drip Prevention Valve

This mechanism prevents coffee from dripping from the Filter Basket when the Glass Carafe is removed from the Main Body.

- Please remove the twist tie holding the Power Cord before use.
- Do not use the Power Cord bundled up. Doing so may cause the Power Cord to become excessively hot, resulting in malfunction.

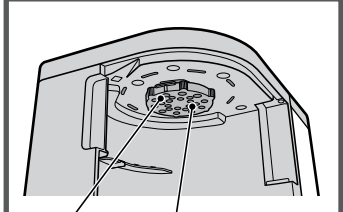

Accessories:

- **Measuring Spoon**
(level off when measuring)
- For 1 cup ☕
(Approx. 0.18 oz. / 5.1 g)
- For 2 cups ☕☕
(Approx. 0.36 oz. / 10.2 g)
- **Basket Coffee Filter (4 pcs.)**
Purchase standard size Basket Coffee Filters (8–12 cups) when you have used up all of the supplied filters.
- **Ice Basket**
To be used exclusively for brewing iced coffee
Use only when brewing iced coffee.
- Do not attach the Ice Basket when you are brewing hot coffee or pouring coffee.

Control Panel

The illustration is for reference only. Actual display will not show all functions simultaneously during use.

Display

CANCEL button

TIMER light

TIMER button

KEEP WARM light

KEEP WARM button

START light

START button

TIME SETTING button

HOW TO SET THE CLOCK

e.g.: If the current time is PM1:01 but displays PM12:58.

1 Insert the Power Plug into an electrical outlet.

The current time appears on the Display.

2 Press the TIME SETTING button (▲ ▼) to set the current time on the Display.

The time display will start to blink.

- ▲ button: Each press advances the time in 1-minute increments.
- ▼ button: Each press moves the clock in reverse by 1 minute.

- Press and hold either button to quickly adjust in 10-minute increments.

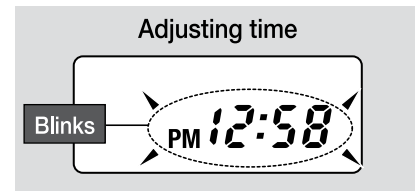

3 The time display will stop blinking after 5 seconds, indicating the Time Setting is completed.

If the time display still does not show the current time, repeat Step 2 to readjust the time.

- If the display shows a blinking "AM7:00" when the Power Plug is inserted, the built-in lithium battery is running out. You may continue using the product and readjust the time each time the Power Plug is plugged in. (To replace the battery → P.19)

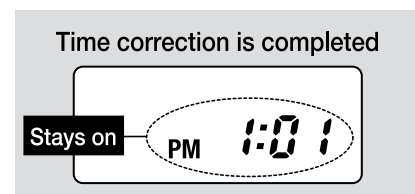

SOUND SIGNALS AND HOW TO CHANGE THEM

This product is equipped with a Sound Signal function, which will inform you when brewing has completed. The product is designed to Beep by default. To change to Silent:

To Change Setting:

- 1 Insert the Power Plug into an electrical outlet.
- 2 Hold the **CANCEL** button for more than 3 seconds.
- 3 The setting is completed when a beep is heard.

- The tone that indicates button inputs will sound even when Silent is selected.
- The selected Sound Signal is stored and will remain even if the product is unplugged.

When Changing the Sound Signal:

Each time the **CANCEL** button is held for more than 3 seconds, the Sound Signal will change.

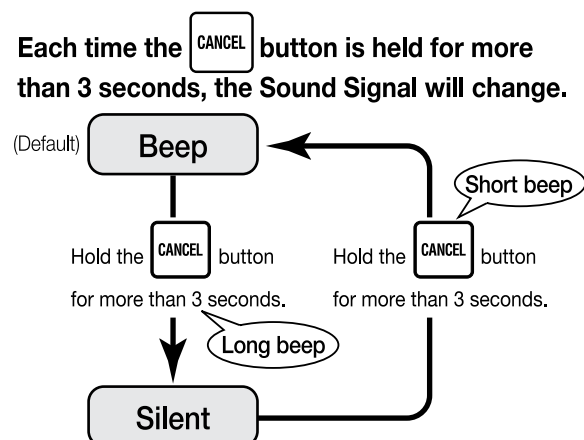

HOW TO ATTACH AND REMOVE EACH PART

Filter Basket

How to Remove

- 1 Open the Swing Basket.
- 2 Remove the Filter Basket.

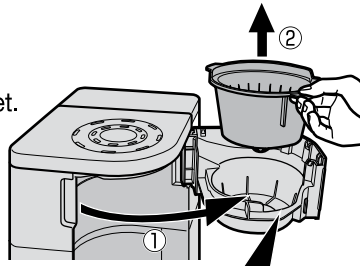

How to Attach

Align the slot on the Swing Basket with the tabs on the Filter Basket to attach.

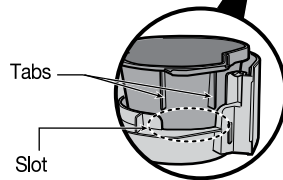

Carafe Lid

How to Remove

Pull up on the Carafe Lid to remove it from the Glass Carafe.



How to Attach

Align part <A> of the Carafe Lid with the Handle of the Glass Carafe to attach the Lid to the Carafe.

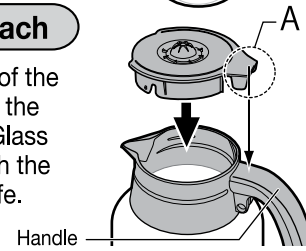

Swing Basket

- Remove the Glass Carafe and the Filter Basket before performing the following.

How to Remove

- 1 Open the Swing Basket fully and lift to undo the bottom tab.

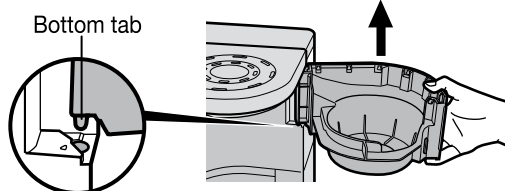

- 2 Slide the Swing Basket in the direction of the arrow and remove the Basket in a downward direction.

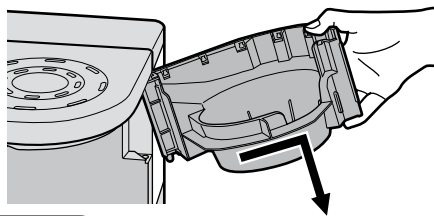

How to Attach

Insert the upper tab of the Swing Basket into the upper slot of the Main Body and then align the lower tab with the lower slot to insert.

Attach the upper tab of the Swing Basket to the position of the "▼" on the top of Main Body.

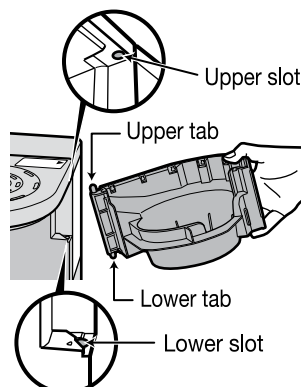

Shower Head

How to Remove

Turn the Shower Head in the direction of the arrow to remove.

- Remove the Shower Head after the Main Body has cooled down completely. (Not doing so may cause burns.)
- Remove the Shower Head carefully as water may leak from it.

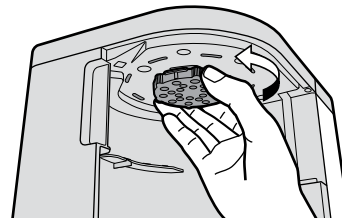

- This illustration shows the view from below.

How to Attach

Align the tabs on the Shower Head with the slots on the Main Body and turn the Shower Head in the direction of the arrow.

- Make sure to set the Shower Head securely.

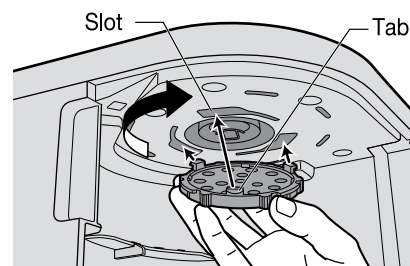

HOW TO USE

● **Prior to initial use or when using the product after a long period of storage:**

Wash the Shower Head, the Glass Carafe, and the Filter Basket, and then operate the product once or twice using only water in order to clean the inside of the Main Body.

- This product is intended for household use only and not for commercial use.
- This product has been designed for brewing coffee only. **Do not use it for any other purpose.** Do not fill the Water Tank with anything other than water (such as milk, alcohol, coffee, or hot water), as doing so may cause malfunction.
- The first time you use the product you may notice the smell of plastic. This is normal and will gradually fade away.
- Do not carry the product by the Swing Basket or Water Tank. Doing so may cause the product to fall.

1 Add ground coffee.

Brewing iced coffee → P.14

- ① Open the Swing Basket and place the Basket Coffee Filter into the Filter Basket.
- ② Measure ground coffee using the provided Measuring Spoon, place in the Basket Coffee Filter and level off the top.
- ③ Close the Swing Basket.

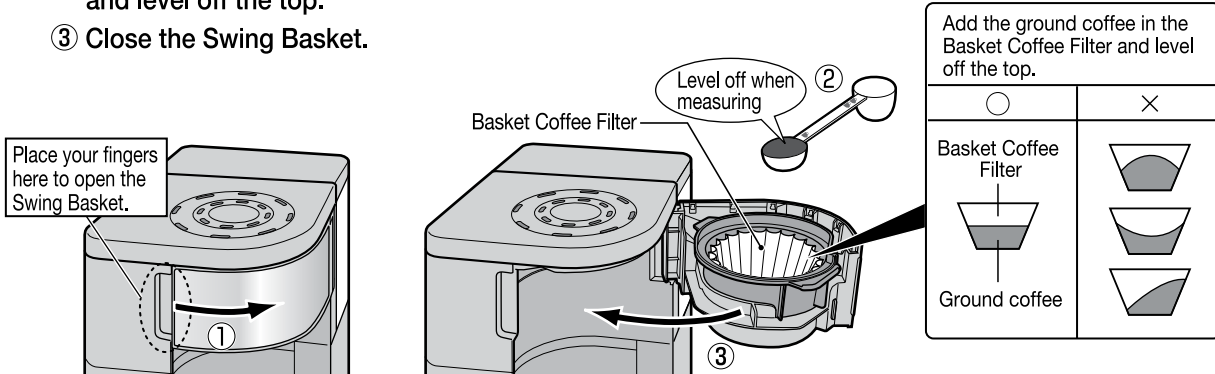

- Do not use fine grind coffee as it may clog the Basket Coffee Filter and coffee may overflow from the Swing Basket.
- Do not brew less than 2 cups.
- When opening and closing the Swing Basket, make sure that the Main Body does not tip over.
- Do not use the product without the Basket Coffee Filter. Otherwise, coffee may overflow from the Swing Basket.
- Put only ground coffee in the Basket Coffee Filter. If you put anything other than ground coffee, coffee may overflow from the Swing Basket, or the product may malfunction.

Hot Coffee Brewing Guidelines

※When using the Measuring Spoon for 1 cup (☺).

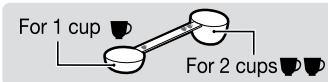

Cups Brewed		2	3	4	5	6	7	8	9	10	11	12
Ground Coffee	In Leveled Measuring Spoon ※	2	3	4	5	6	7	8	9	10	11	12
	Approx. oz.	0.36	0.54	0.72	0.9	1.08	1.26	1.44	1.62	1.8	1.98	2.16
	Approx. g	10.2	15.3	20.4	25.5	30.6	35.7	40.8	45.9	51	56.1	61.2

HOW TO USE (cont.)

2 Fill the Water Tank with water.

① Remove the Water Tank from the Main Body.

- Hold down the Main Body and carefully remove the Water Tank. If you are not careful, the Main Body may lift with the Tank and fall. (Do not touch the Steam Vent.)

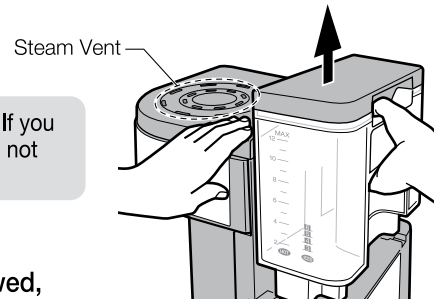

② Use the Scale on the Water Tank and fill to the line corresponding to the number of cups of coffee being brewed, and then close the Water Tank Lid.

- The Scale on the Glass Carafe is not the Scale for the amount of water to be added to the Water Tank. Be sure to fill the Tank with water in accordance with the Scale on the Water Tank.

Be sure to follow the instructions below to prevent a malfunction, water leak, or overflowing of coffee.

- Do not add water above the MAX line (level 12) on the Water Tank.
- Do not refill the Water Tank while coffee is brewing.
- Do not fill the Water Tank with hot water.

The Scale on the Water Tank

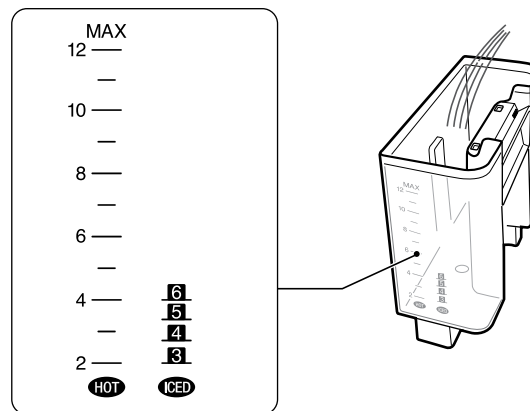

Precautions When Using Hard Water:

- Do not use water with 400ppm or more total dissolved solids.
Scale (formed from minerals contained in water) may build up inside the pipes of the product and hinder the brewing performance. For example, brewing may take longer or water may not drip properly.
- We recommend using water with 200ppm or less total dissolved solids.
- If brewing takes longer than usual, please clean the product using citric acid. (→P.18)

HOW TO USE (cont.)

3 Set the Water Tank and the Glass Carafe in the Main Body.

① Be sure that the Water Tank is securely attached onto the Main Body with the bottom firmly seated.

② Place the Glass Carafe on the Keep Warm Plate.

- Before placing the Glass Carafe on the Keep Warm Plate, be sure to check that the Plate is not dirty and contains no moisture. Using the product when the Keep Warm Plate is dirty or when there is moisture on the Plate may cause the coating to peel off or become discolored.
- Do not scrape the Glass Carafe against the Keep Warm Plate when you place it on the Keep Warm Plate.

- Do not attach the Ice Basket when you are brewing hot coffee.
- Be sure to place the Carafe Lid on the Glass Carafe. (→P.8) Not doing so may hinder the Drip Prevention Valve from opening and coffee may overflow from the Filter Basket.
- When putting the Glass Carafe in place, do not apply excessive force to the Drip Prevention Valve.

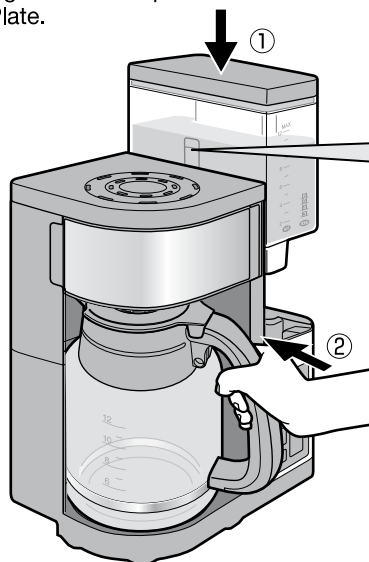

- Align the slot on the Water Tank with the tab on the Main Body.

Slot on the Water Tank

Tab on the Main Body

Lower the Water Tank straight along the Main Body.

Attach the Water Tank securely with the bottom firmly seated.

- Malfunction may occur if the Water Tank is not attached securely. Hot water also may not dispense during brewing.

4 Insert the Power Plug into the electrical outlet and select the KEEP WARM mode.

Press the button and select the KEEP WARM mode.

- Every time you press the button, the indication for the KEEP WARM mode changes.

MED → **HI** → **MED** → **LOW** → **OFF**
 (Default) ↑

- You can change the KEEP WARM mode while the coffee is being brewed.
- The KEEP WARM mode cannot be changed while coffee is being kept warm. (→P.13)
- The selected KEEP WARM mode is stored and retained even after the product is unplugged.
- When you set the KEEP WARM mode to “OFF”, the coffee is not kept warm. Use the “OFF” mode when brewing iced coffee.

- Do not use or place the product on wet surfaces. Doing so may cause electric shock.

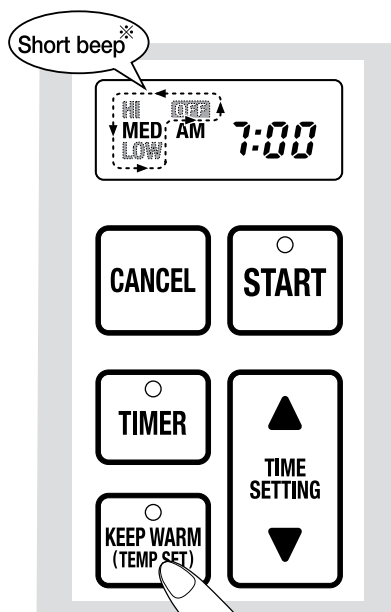

※ Two short beeps are emitted when the KEEP WARM mode is set to “MED”.

HOW TO USE (cont.)

5 Press the button.

The position of  moves on the Display.

The START light and KEEP WARM light will turn on and brewing will begin.

The Keep Warm function is automatically activated as soon as the coffee begins brewing.

(When the KEEP WARM mode is set to "OFF", the KEEP WARM light turns off and the coffee is not kept warm.)

The Display will look like the illustration on the right during brewing.

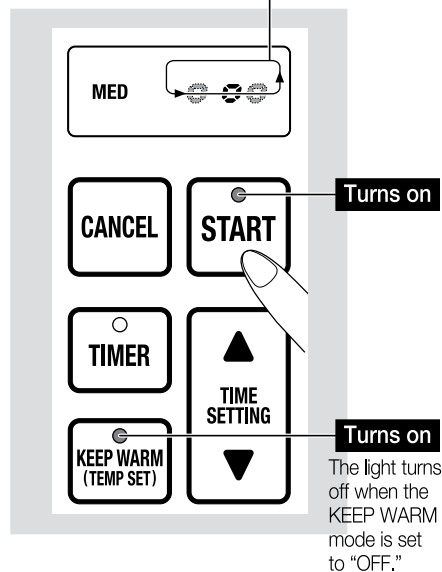

Estimated Time Until Completion:

[based on water and room temperature of 68°F (20°C)]

Cups	2	3	4	5	6	7
Estimated Time	5 min.	6 min.	6.5 min.	7 min.	8 min.	8.5 min.
Cups	8	9	10	11	12	
Estimated Time	9.5 min.	10.5 min.	11 min.	12 min.	12.5 min.	

- The estimated time until completion may vary depending on the amount of water, water temperature and the amount of ground coffee.

How to Cancel Brewing in the Middle of the Process

- ① Press the CANCEL button.
- ② Make sure the Main Body has cooled down and coffee is no longer dripping from the Filter Basket and then remove the Glass Carafe and the Filter Basket.
- ③ Remove the Water Tank and discard the remaining water.
 - Water may drip when removing the Water Tank.
 - Press the CANCEL button only to cancel during brewing. If the CANCEL button is pressed accidentally, press the START button to continue brewing.

Automatic Shut-Off Function

Beeps will sound, the START light and TIMER light turn on and "HH" will appear on the Display.

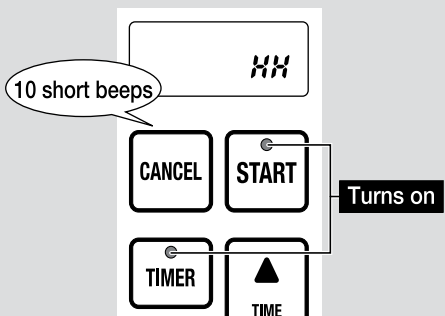

The Automatic Shut-Off function activates to shut off power to the heater in order to prevent damage from overheating. The Display will show "HH" to alert you that the Automatic Shut-Off has been activated. The following conditions may cause activation:

- When the START button is pressed without filling the Water Tank with water.
- When the water level is lower.
- When brewing coffee consecutively without allowing the Main Body to cool.

Remedy Press the CANCEL button. Allow the product to cool. Fill the Water Tank with water and press the START button.

6 When brewing completes, pour coffee.

- When brewing is finished, a beep will sound, the START light will turn off, and the Display will show the time elapsed since completion of the brewing in 10-minute intervals.
- Remove the Glass Carafe and pour coffee into a cup.
 - Do not scrape the Glass Carafe against the Keep Warm Plate when you remove it from the Plate.

For very hot coffee, preheat cups with hot water or use other methods when serving.

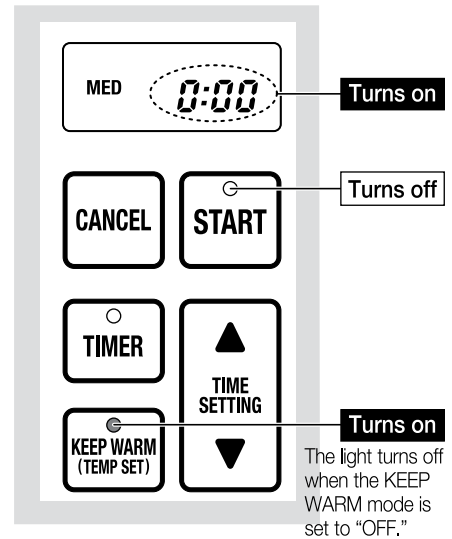

- This coffee maker uses a high water temperature setting for the drip function to enable the full taste of the coffee beans to come through. For that reason, the oil content of coffee beans may rise to the surface of the coffee. This oil content, however, does not affect the taste or other aspects of the coffee.

When Keeping the Coffee Warm After Brewing Has Completed

- Set the KEEP WARM mode to "HI", "MED", or "LOW".
- Keep the coffee warm without removing the Carafe Lid from the Glass Carafe.
 - The aroma and flavor of the coffee will deteriorate if it is left in the Glass Carafe for a long time. As a guideline, it is recommended to keep the coffee warm for no longer than 30 minutes.
 - Do not use the Keep Warm function when the amount of coffee remaining in the Glass Carafe is lower than the guideline in the illustration below.

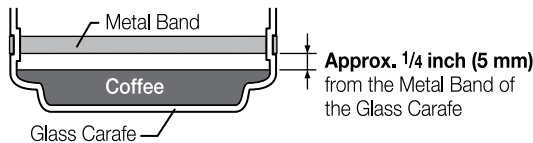

- Once the coffee becomes cold, you cannot warm up the coffee using this function.
- The KEEP WARM feature cannot be used while the Timer is set or the time is being set.

The KEEP WARM mode cannot be changed while coffee is being kept warm. To change the KEEP WARM mode:

- Press the CANCEL button to cancel the current KEEP WARM function.
- Press the KEEP WARM button and select the desired KEEP WARM mode.
- Hold the KEEP WARM button for more than 3 seconds. (The KEEP WARM light turns on.)

The Keep Warm function will automatically turn off after coffee is kept warm for the following amount of time:

KEEP WARM Mode	Time Elapsed After Brewing Completion
HI/MED	approx. 1 hour
LOW/OFF	approx. 2 hours

Beeps will sound, the heater will shut off automatically, and the current time will appear on the Display. (The KEEP WARM light turns off.)

- To continue keeping coffee warm, hold the KEEP WARM button for more than 3 seconds to resume the Keep Warm function. (The KEEP WARM light turns on.)

If you have accidentally unplugged the Power Plug from the electrical outlet

If you have accidentally unplugged the Power Plug from the electrical outlet while the coffee is being kept warm, insert the Power Plug into the electrical outlet, and then hold the KEEP WARM button down for more than 3 seconds. (The KEEP WARM light turns on.)

When Brewing Coffee Consecutively

- To brew your next pot of coffee, be sure to wait at least 5 minutes after pressing the CANCEL button, and then follow "HOW TO USE" from step 1. (→ P.9)
- Do not add water or move the product while it is still hot.

7 After use

Press the CANCEL button. (The KEEP WARM light turns off and the current time appears on the Display.)

Unplug the Power Plug from the electrical outlet. (All messages turn off on the Display.)

HOW TO USE (cont.)

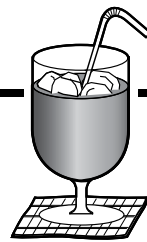

BREWING ICED COFFEE

Required items

- ◆ Ground coffee for iced coffee
- ◆ Ice cubes

- When you brew iced coffee, be sure to use the Ice Basket with the Carafe Lid in the Glass Carafe.
- You can brew 3–6 cups of iced coffee.
- Do not use the Timer function when brewing iced coffee.

Iced Coffee Brewing Guidelines and Estimated Time Until Completion

Cups Brewed		3	4	5	6
Ground Coffee	In Leveled Measuring Spoon ^{※1}	5	7	9	11
	Approx. oz.	0.9	1.26	1.62	1.98
	Approx. g	25.5	35.7	45.9	56.1
Estimated Time ^{※2}		5 min.	5.5 min.	6 min.	6.5 min.

※1 When using the Measuring Spoon for 1 cup (☐).

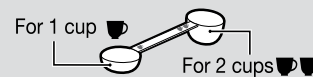

※2 based on water and room temperature of 68°F (20°C)

- The estimated time until completion may vary depending on the amount of water, water temperature and the amount of ground coffee.

How to Brew Iced Coffee

- 1 Put the appropriate amount of ice cubes in the Ice Basket for the number of cups of iced coffee you want to brew. Place the Carafe Lid on the Ice Basket.

Ice Amount Guidelines

Cups Brewed	Amount of ice
5–6 cups	Up to the level of the upper holes [Approx. 14.8 oz. (Approx. 420 g)]
3–4 cups	Up to the level of the lower holes [Approx. 11.1 oz. (Approx. 315 g)]

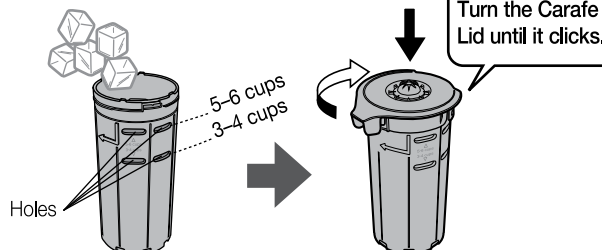

- If you put large ice cubes in the Ice Basket, the coffee may not cool sufficiently.
- Large gaps between ice cubes may prevent coffee from cooling sufficiently. After placing the ice cubes, gently shake the Ice Basket to reduce any gaps.
- Do not add ice to the Ice Basket beyond the maximum amount to avoid causing coffee to overflow from the Glass Carafe. (Maximum Ice Amount: 14.8 oz. / 420 g)

- 2 Set the Ice Basket in the Glass Carafe.

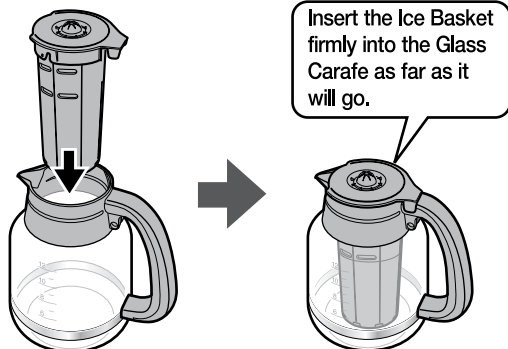



- 3 Follow the instructions under “HOW TO USE” from steps 1 to 5 (P.9 to P.12) to brew the coffee.

- Set the KEEP WARM mode to “OFF”. If the KEEP WARM mode is not set to “OFF”, the coffee is kept warm and you cannot brew iced coffee.
- Fill the Water Tank with water up to the **ICED** mark on the Water Tank, depending on the number of cups you want to make.
- Do not add water to the Water Tank beyond the **ICED** maximum volume to avoid causing coffee to overflow from the Glass Carafe. (Maximum Water Volume: 20.3 oz. / 600 mL)

HOW TO USE (cont.)

ATTACH AND REMOVE THE ICE BASKET LID

How to Attach

- 1 Align the  of the Carafe Lid with the  mark on the Ice Basket, and press the Lid down onto the Ice Basket.
- 2 Turn the Carafe Lid in the direction of the arrow.

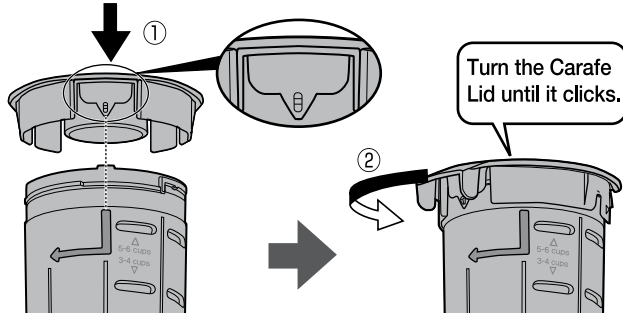

- If attached incorrectly, the Carafe Lid may come off the Ice Basket.

How to Remove

- 1 Turn the Carafe Lid in the direction of the arrow.
- 2 Pull up on the Carafe Lid to remove it from the Ice Basket.

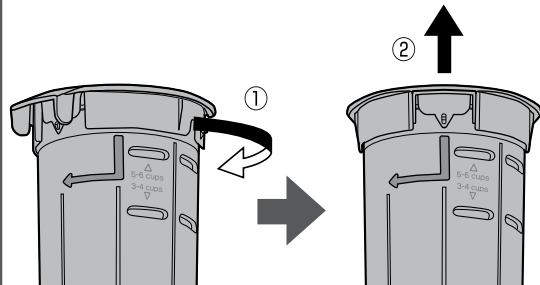

- 4**
 - 1 When brewing is finished, press the **CANCEL** button and unplug the Power Plug from the electrical outlet.
 - 2 Remove the Glass Carafe and gently swirl the coffee 2–10 times to even out the temperature and strength of coffee.
 - 3 Remove the Ice Basket from the Glass Carafe.

- Remove the Ice Basket carefully as there may be some coffee or ice cubes left in the Ice Basket.

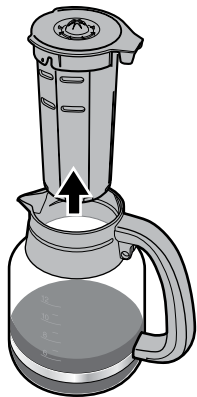

- 5** Remove the Carafe Lid and discard the ice cubes remaining in the Ice Basket.

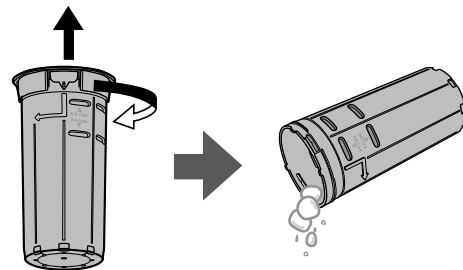

- 6** Place the Carafe Lid on the Glass Carafe and pour the coffee into a glass with ice cubes.

- Always remove the Ice Basket before pouring coffee. The Ice Basket may fall out and cause coffee or ice to spill if not removed.



HOW TO SET THE TIMER

The Timer allows you to delay the time to begin brewing.

- The Timer can be set from the current time until 24 hours in advance.
- Do not set the timer too far in advance if the room temperature is high, such as during summer. Doing so may cause water quality to deteriorate or the aroma and flavor of the coffee to be lost.
- Press the TIME SETTING button (▲▼) to check the current time during Timer setting.
- Do not use the Timer function when brewing iced coffee.

e.g.: To set the Timer for AM7:00 when the current time is PM11:00.

1 Prepare the product for brewing and press the button.

The current time on the Display and the TIMER light will begin to blink.

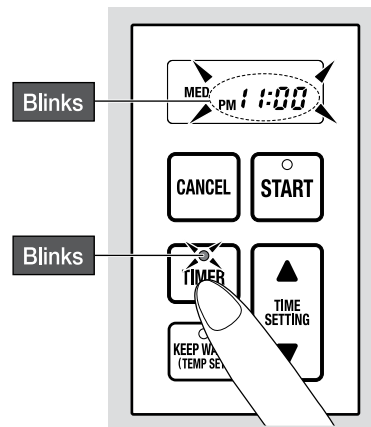

2 Press the TIME SETTING button (▲▼) to select the time you want to begin brewing.

- ▲ button: Advances the clock in 10-minute increments.
- ▼ button: Moves the clock in reverse in 10-minute increments.

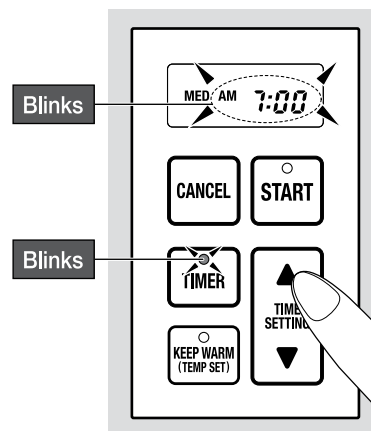

3 Press the button and select the KEEP WARM mode.

(See step 4 under "HOW TO USE" on P.11)

4 Press the button.

When the time on the Display and the TIMER light stop blinking and stay on, the Timer has been set properly.

The Display will indicate the time at which brewing will begin.

- The START button must be pressed for the product to be brewed automatically.
- The KEEP WARM feature cannot be used while the Timer is set.

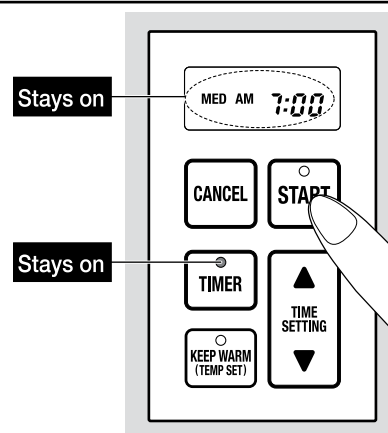

To Cancel the Timer Setting

- Press the CANCEL button. (The TIMER light will turn off and the Display will show the current time.)

CLEANING AND MAINTENANCE

Always unplug the product from the electrical outlet and allow it to cool completely before cleaning.

- Be sure to clean the product after every use.
- Do not splash the Main Body, Power Cord and Power Plug with water or immerse them in water. Doing so may cause electric shock or malfunction.
- Do not use hot water to wash the product or parts as they may deform or break.
- Do not use the following:
 - Detergents other than mild kitchen detergent, such as thinner and bleach. Doing so may cause discoloration, cracks, degradation or corrosion.
 - Polishing powder, nylon brushes, scrub brushes, anything made with metal, eraser pads, hard nylon sponges and abrasive cleaners. Doing so may cause corrosion.
- When using chemically treated cloths, do not rub too hard or leave them on the product for a long time as the surface of the product may become damaged from chemical reactions.
- Do not use a dishwasher or a dish-dryer. Doing so may cause deformation.

Main Body

- ① Wipe the Main Body clean with a soft cloth immersed in diluted mild kitchen detergent and wrung well.
- ② Wipe with a well-wrung soft damp cloth.
- ③ Wipe dry with a soft dry cloth.

Water Tank, Water Tank Lid, Swing Basket, Ice Basket, Glass Carafe and Carafe Lid

- ① Wash with a sponge or soft material with diluted mild kitchen detergent.
- ② Rinse with water.
- ③ Wipe dry with a soft dry cloth.

- Be sure to fully drain water from the Swing Basket. Otherwise, this water may drip into your coffee during brewing.

Shower Head

Rinse the Shower Head under running water and dry well.

- Do not disassemble the Shower Head. If the Shower Head becomes disassembled, reassemble it correctly as shown below.

Align the slots (3 locations) on the Upper Shower Head with the tabs (3 locations) on the Lower Shower Head to attach.

Upper Shower Head
Slots
Lower Shower Head
Tabs

Filter Basket

- ① Wash the Filter Basket clean with a sponge or soft material with diluted mild kitchen detergent.
- ② Rinse with water.
- ③ Pour water in the Filter Basket, press the Drip Prevention Valve two or three times and wash.
- ④ Wipe dry with a soft dry cloth.

- If coffee grounds clog the Drip Prevention Valve, it may not seal properly and coffee may overflow. Be sure to wash it after each use.
- Be sure to fully drain water from the Filter Basket. Otherwise, this water may drip into your coffee during brewing.
- Handle the Drip Prevention Valve carefully. Pulling on it may cause it to come off.

Drip Prevention Valve

- Do not disassemble the Drip Prevention Valve. If it comes off, reattach correctly as shown below.

- ① Place the spring on the Filter Basket.
- ② Insert the Drip Prevention Valve through the spring and into the opening of the Filter Basket.
- ③ Hold the Drip Prevention Valve in and attach the Rubber Gasket to the groove from the inside.

Drip Prevention Valve
Spring
Opening
Filter Basket
Rubber Gasket
Groove
Attach the Rubber Gasket here.

○	Attached correctly	
✗	Loose	Water may leak from gaps

Be sure that the Rubber Gasket is attached securely. Water may leak if it is attached twisted or is loose.

Power Cord and Power Plug

Wipe with a soft dry cloth.

CLEANING AND MAINTENANCE (cont.)

If "CLEAN" appears on the Display, or hot water is not dispensed smoothly, clean using citric acid.

MED **CLEAN** **7:00** **Turns on**

- When "CLEAN" appears on the Display, clean using citric acid or hold the TIMER button for more than 3 seconds while the Display shows the current time. After the above operation, the message "CLEAN" will turn off.

Minerals contained in water may build up inside the pipes and other parts with use. These minerals are called "scale".
If scale accumulates, water may not be dispensed smoothly, the amount of coffee brewed may be reduced, or hot water may leak from gaps in the Main Body.

- The amount of scale build-up varies depending on the type and quality of water. More scale may build up if living in areas with hard water or when using mineral-rich water.
- Perform citric acid cleaning about every 4 weeks of usage.

Use the following procedure to remove scale.

How to Perform Citric Acid Cleaning

- Put 1 package of the Citric Acid Cleaner CD-K03E-JU in a cup and add warm water to dissolve. Pour it into the Water Tank and fill with water to level 12 (MAX) on the Water Tank.
- Stir the citric acid solution well.
- Set the Water Tank, Glass Carafe (with the Carafe Lid attached), Filter Basket, and Swing Basket to the Main Body.
- Hold the START button for more than 3 seconds to initiate the citric acid cleaning process.

● In order to prevent gas bubbles and bubbling-over, the Citric Acid Cleaner for Electric Water Boilers (CD-K03E-JU) is recommended for cleaning. (Available separately) →P.5

Citric acid (100%) is used as a food additive and is harmless from a food sanitation standpoint, but do not consume it.

- To stop the citric acid cleaning process before it finishes, press the CANCEL button. If cleaning was cancelled before it finished, restart the cleaning process from step ①.

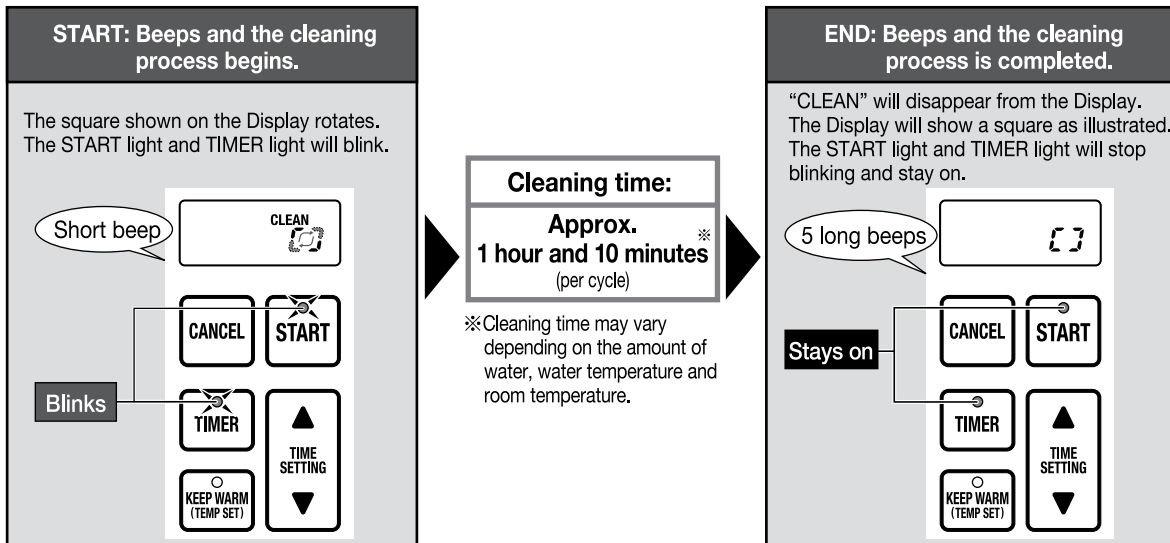

- Press the CANCEL button.
 - When brewing completes, pour the citric acid solution from the Glass Carafe to another container to cool, then remove any scale (white crystals, etc.) floating in the solution.
 - Pour citric acid solution from step ⑥ back into the Water Tank and repeat steps ④ to ⑥ until there are no more scale.
 - After the Main Body has cooled down completely, discard the citric acid solution in the Glass Carafe and the Water Tank. Rinse and repeat the brewing process using only water a few times in order to remove the citric acid odor. (When brewing more than one carafe of coffee, wait **at least 5 minutes** after the START light turns off before starting the next brewing cycle.)
 - Press the CANCEL button and unplug the Power Plug from the electrical outlet.
- If hot water is not dispensed smoothly, perform citric acid cleaning again.

TROUBLESHOOTING GUIDE

Please check the following before calling for service.

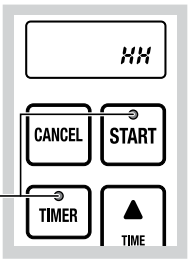
Condition	Cause	Remedy
The product does not operate even when the START button is pressed.	Is the Power Plug inserted correctly?	Insert the Power Plug into the electrical outlet.
Hot water is not dispensed. Hot water is not dispensed smoothly.	Is the Water Tank filled with water?	Pour water into the Water Tank. (→ P.10)
	Is the Water Tank set correctly?	Set the Water Tank correctly. (→ P.11)
	When scale accumulates inside the pipes and other parts, hot water may not be dispensed smoothly. In that case, perform citric acid cleaning. (→ P.18)	
Hot water is not dispensed smoothly and brewing speed is slow.	When scale accumulates inside the pipes and other parts, hot water may not be dispensed smoothly. In that case, perform citric acid cleaning. (→ P.18)	
Coffee grounds overflow from the Basket Coffee Filter.	Is finely-ground coffee being used?	Please do not use finely-ground coffee.
	Is too much ground coffee being used?	Please reduce the amount of ground coffee.
	Depending on the type of coffee or Basket Coffee Filter being used, coffee grounds may overflow from the Basket Coffee Filter. In this case, reduce the amount of coffee grounds. If coffee grounds continue to overflow, please contact Zojirushi Customer Service or visit www.zojirushi.com/coffeefilter	
The coffee is not hot (the Glass Carafe is not retaining heat properly).	Is the KEEP WARM mode set to "OFF" or "LOW"?	Set the KEEP WARM mode to "HI" or "MED". (→ P.11)
"AM7:00" is blinking on the Display when the Power Plug is inserted.	The built-in lithium battery is running out. Readjust the clock to use the product in a normal manner. To replace the lithium battery, contact the store where you purchased the product or Zojirushi Customer Service. (There will be a charge for the service.)	
Beeps sounds, the START light and TIMER light turn on and HH appears on the Display.	 <p>Is the Water Tank filled with water? Is the Water Tank low on water? Did you try to brew coffee consecutively without allowing the Main Body to cool?</p>	The Automatic Shut-Off function has been engaged. (→ P.12) Press the CANCEL button and wait until the product cools down. Fill with water and press the START button.
E2 , E3 , E4 or E5 is displayed.	Indicates malfunction. Please contact Zojirushi Customer Service.	
The Power Cord becomes hot.	The Power Cord may become hot while the product is turned on. This is not a malfunction.	



www.zojirushi.com

FOR CALIFORNIA USA ONLY

This product contains a CR Coin Lithium Battery which contains Perchlorate Material - special handling may apply. See www.dtsc.ca.gov/hazardouswaste/perchlorate

EC-YGC (F)(E)(D)