



GOURMET ROASTER OPERATING INSTRUCTIONS

EF-VSC40

INDEX

IMPORTANT SAFEGUARDS.....	2
PARTS NAMES.....	6
HOW TO USE.....	7
HOW TO DISASSEMBLE.....	10
CLEANING AND MAINTENANCE.....	11
TROUBLESHOOTING GUIDE.....	12
SPECIFICATIONS.....	13

IMPORTANT SAFEGUARDS

Basic safety precautions should always be followed when using electrical appliances, including the following:

1. Read all instructions thoroughly.
2. Avoid touching hot surfaces and do not close or clog the exhaust duct or air duct under any circumstances. The handles and knobs are provided for your safety and protection.
3. To safeguard against fire, electric shock and possible injury, keep the power cord, plugs and the appliance away from water or other liquids.
4. Close supervision is necessary when any appliance is used by or near children.
5. Unplug from outlet when not in use and before cleaning. Allow the appliance to cool before adding or removing parts, and before cleaning the appliance. Make sure appliance is OFF when not in use, before putting on or taking off parts, and before cleaning.
6. Do not operate any appliance with a damaged cord or plug. If the appliance malfunctions or has been damaged in any manner, unplug the appliance and return it to the nearest authorized service facility for examination, repair or adjustment.
7. The use of accessories or attachments not recommended by the appliance manufacturer may result in fire, electric shock or other injury to persons.
8. Do not use outdoors.
9. Keep the power cord away from hot surfaces and do not let the cord hang over the edge of tables or counters.
10. Do not place on or near a heated surface such as a gas or electric stove, or in a heated oven.
11. Always use extreme cautions when moving appliances containing hot contents or liquids.
12. Plug the cord into a household electrical outlet. To disconnect, turn the power control to OFF, then remove plug from wall outlet.
13. Do not use the appliance for other than intended use.

SAVE THESE INSTRUCTIONS

THIS APPLIANCE IS FOR HOUSEHOLD USE ONLY.

This appliance is supplied with a short power cord to reduce the risk of becoming entangled in or tipping over. Extension cords may be used if care is exercised in their use. If an extension cord is used, the marked electrical rating of the cord should be at least as great as the electrical rating of the appliance, and longer cord should be arranged so that it will not drape over the countertop or tabletop where it can be pulled on by children or tripped over unintentionally.

This appliance has a polarized plug (one blade is wider than the other). To reduce the risk of electric shock, this plug was designed to fit into polarized outlet in only one direction. If the plug does not fit fully into the outlet, do not attempt to force it or modify it in any way. Simply reverse the plug and insert. If it still does not fit, contact a qualified electrician.

IMPORTANTES MESURES DE SÉCURITÉ

Pour utiliser des appareils électriques, il faudrait toujours prendre les précautions de base, y compris les suivantes.

1. Lisez toutes les instructions.
2. Veuillez éviter de toucher les surfaces chaudes et ne JAMAIS fermer ou obstruer le conduit d'évacuation ou l'amenée d'air. Les poignées et les boutons sont conçus pour votre sécurité et votre protection.
3. Pour éviter les chocs électriques, ne plongez pas le cordon, la fiche ou l'appareil portatif dans l'eau ou un autre liquide.
4. Surveillez bien les enfants s'ils utilisent un appareil ou s'ils se trouvent à proximité d'un appareil en marche.
5. Débranchez l'appareil après usage ou avant de le nettoyer. Laissez l'appareil refroidir avant d'en retirer ou d'y insérer les accessoires et avant de le nettoyer. Assurez-vous que l'appareil est sur OFF lorsque vous ne vous en servez pas, avant d'en retirer ou d'y insérer les accessoires détachables ou encore avant de le nettoyer.
6. Appareils portatifs. Ne faites pas fonctionner l'appareil si le cordon ou la fiche sont endommagés, si l'appareil ne fonctionne pas correctement, s'il est tombé ou s'il a été endommagé. Confiez au service de réparation recommandé le plus proche tout examen, réparation ou réglage électrique ou mécanique de l'appareil.
7. L'utilisation d'accessoires non recommandés par le fabricant de l'appareil peut causer des blessures.
8. N'utilisez pas l'appareil à l'extérieur.
9. Ne laissez pas le cordon pendre par-dessus le bord d'une table ou d'un comptoir et assurez-vous que le cordon n'est pas en contact avec des surfaces chaudes.
10. Ne placez pas l'appareil près d'un brûleur à gaz allumé ou d'un élément électrique ou tension ou dans un four allumé.
11. Soyez très prudent lorsque vous déplacez l'appareil contenant un liquide ou un aliment chaud.
12. Branchez le cordon dans une prise domestique. Avant de débrancher l'appareil, placez-le sur la position ARRÊT puis retirez la fiche de la prise murale.
13. N'utilisez l'appareil que pour la fonction à laquelle il est destiné.

CONSERVEZ CES INSTRUCTIONS

CET APPAREIL EST UNIQUEMENT À USAGE DOMESTIQUE.

L'appareil est équipé d'un cordon court afin de réduire les risques d'enchevêtrement ou de chutes sur le cordon. Des rallonges peuvent être utilisées à condition que toutes les précautions soient prises lors de leur utilisation.

Si vous vous servez d'une rallonge, sa puissance électrique indiquée devra être égale ou supérieure à celle de l'appareil; Le cordon devra être arrangé de manière à ce qu'il ne pende pas depuis le haut d'un comptoir ou d'une table où il serait à portée de main des enfants et où il occasionnerait des accidents dus à une chute ou à un enchevêtrement. L'appareil a une prise polarisée (l'une des lames est plus large que l'autre). Pour réduire les risques de chocs électriques, la prise s'insère dans un seul sens à l'intérieur d'une prise murale polarisée. Si la prise ne s'adapte pas correctement dans la prise murale, retournez-la. Si elle ne s'adapte toujours pas, contactez un électricien spécialisé. Ne cherchez en aucun cas à modifier la prise.

IMPORTANT SAFEGUARDS

Be sure to follow the instructions.

- These WARNINGS and CAUTIONS are intended to protect you and others from personal injury and household damage. To ensure safe operation, please follow carefully.

 **WARNINGS** Indicates risk of serious injury. ※1

 **CAUTIONS** Indicates risk of injury or property damage if mishandled. ※2 ※3

※1 Serious injury includes loss of eyesight, burns (high and low temperature), electric shock, bone fractures, toxic reactions as well as other injuries severe enough to require medical care or extended hospitalization.

※2 Injury indicates physical damage, burns or electric shock not severe enough to require medical care or extended hospitalization.















 **CAUTIONS** Indicates a warning or caution. A specific caution is indicated inside or near the triangle by sentences or illustrations.

 **PROHIBITED** Indicates a prohibited operation. A specific prohibited operation is indicated inside or near the circle by sentences or illustrations.

 **INSTRUCTIONS** Indicates a requirement or instruction that must be followed. A specific instruction is indicated inside or near the circle by sentences or illustrations.



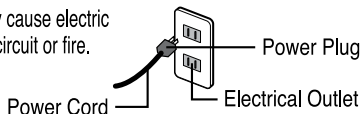











※3 Property damage indicates material damage towards a home, furniture, or pets and animals.

WARNINGS

<p> Do not modify the product. Only a repair technician may disassemble or repair this unit. Attempting to do so may cause fire, electric shock or injury. Make any repair inquiries to Zojirushi Customer Service.</p>	<p> If the blades or surface of the Power Plug become soiled, wipe them clean. A dirty Power Plug may cause fire.</p>
<p> Do not immerse the product in water or splash it with water. Doing so may cause short circuit or electric shock.</p>	<p> Use only an electrical outlet rated at 15 amperes minimum, and do not plug other devices into the same outlet. Plugging other devices into the same outlet may cause the electrical outlet to overheat, resulting in fire.</p>
<p> Do not plug or unplug the Power Cord if your hands are wet. Doing so may cause an electric shock or injury.</p>	<p> Insert the Power Plug completely and securely into the electrical outlet. A loosely inserted Power Plug may cause electric shock, short circuit, smoke or fire.</p>
<p> Do not use a power source other than 120V AC. Use of any other power supply voltage may cause fire or electric shock.</p>	<p> Stop using immediately if you notice any of the following symptoms indicating a malfunction or breakdown. Continued use of the product may cause smoke, fire, electric shock or injury.</p> <ul style="list-style-type: none"> • The Power Plug or Power Cord has become very hot. • The Power Cord is deeply damaged or deformed. • There is a burning smell. • One or more parts of the product is cracked, loose or unstable. • The electricity turns on and off when the Power Cord is touched or moved. • You feel a tingle or slight electrical shock. • The product does not operate even though the Timer Knob is turned ON. <p>If you notice any of the above symptoms, unplug the product immediately and contact the store where you purchased it or Zojirushi Customer Service for check-ups and/or repairs.</p>
<p> Do not use the product near flammable materials such as a curtain. Doing so may cause fire.</p>	<p> This product is not intended for use by persons (including children) with reduced physical, sensory or mental capabilities, or lack of experience and knowledge, unless they have been given supervision or instruction concerning use of the appliance by a person responsible for their safety. Children should be supervised to ensure that they do not play with the appliance.</p>
<p> Do not allow children to use the product unsupervised. Keep it out of the reach of infants. Children are at risk of burns, electric shock or injury.</p>	
<p> Do not use the product if the Power Plug or Power Cord is damaged or if the Power Plug is loosely inserted into the electrical outlet. Doing so may cause electric shock, short circuit or fire.</p> <div style="text-align: center;">  </div>	
<p> Do not damage the Power Cord. Do not bend, pull, twist, fold, or attempt to modify the Power Cord. Do not place it on or near high temperature surfaces or appliances, under heavy items or between objects. A damaged Power Cord can cause fire or electric shock.</p>	

- The illustrations used in this Operating Instructions may vary from the actual product you have purchased.

⚠ CAUTIONS

<p> Do not touch hot surfaces during or immediately after use. Touching hot surfaces may cause burns.</p>	<p> Unplug the Power Plug from the outlet when the product is not in use. Leaving the Power Plug in an outlet may cause the insulation to become damaged, resulting in electric shock, short circuit or fire.</p>
<p> Do not place or use the product on unstable surfaces or on surfaces that are vulnerable to heat. Doing so may cause fire.</p>	<p> During preheating or cooking, move birds and small animals that may be sensitive to smoke or smells to other rooms, and open windows or turn on exhaust fans.</p>
<p> Do not overheat the product. Doing so may cause the product to catch fire.</p>	<p> Always unplug the product by holding the Power Plug, not by pulling the Power Cord. Pulling the Power Cord to unplug the product may cause electric shock, short circuit or fire.</p>
<p> Never leave the product unattended during operation. Foods may catch fire.</p>	<p> Please allow the product to cool down before cleaning. Some parts may cause burns when hot.</p>
<p> Do not operate the product with objects on top or underneath it. The product or object may deform, melt or cause fire.</p>	<p> Be sure to clean after every use. Food scraps and oil left behind may cause smoke or catch fire.</p>
<p> Do not use the product near walls, furniture or beneath shelving. Heat may damage, discolor or deform walls, furniture or shelving.</p>	<p> Always make sure the Water Tray is set before use. Operating the product without the Water Tray may cause it to catch fire.</p>
<p> Do not use for other than intended purposes.</p>	<p> If the Power Cord is damaged, it must be replaced by the manufacturer, its service agent or similarly qualified persons to avoid hazards.</p>
<p> If foods begin to smoke or catch fire, immediately turn the Timer OFF and unplug the Power Plug. If foods catch fire, do not open the Lid until the flame extinguishes. Do not attempt to put out the fire by pouring water on it, as it may cause the Glass Window to break.</p>	

⚠ IMPORTANT

<p>■ Keep your face away from the product when opening the Lid during or immediately after cooking. Hot steam or smoke may arise and cause scalding.</p>	<p>■ Always add water in the Water Tray when operating the product. Operating the product without water in the Water Tray may cause fire.</p>
<p>■ Add more water to the Water Tray when cooking consecutively. Do not cook consecutively if the food is rich in oil or fat. Doing so may cause fire.</p>	<p>■ Do not use cooking sheets or baking stones. Doing so may cause smoke, fire or burns.</p>
<p>■ Do not splash water on the Glass Window while in operation. Doing so may damage the Glass Window.</p>	<p>■ Do not cook foods that may expand in size or become warped such as rice cakes or dried squids. Foods may come in contact with the Heaters and cause fire.</p>
<p>■ Do not operate the product without placing foods inside. If the product is accidentally turned on without foods inside, allow it to cool down naturally. Forcing it to cool down with use of water or other methods may damage the product.</p>	<p>■ Be sure to close the Lid. Operating the product with the Lid open may cause fire.</p>
<p>■ Handle the Lid and Water Tray gently. This will prevent damages to the product.</p>	<p>■ Do not operate the product on surfaces that are vulnerable to heat such as tablecloths or carpets. Doing so may cause fire.</p>
<p>■ Do not tilt the product. Water may spill or cause breakdown of the product.</p>	<p>■ Do not carry the product by the Lid Handles. The Lid or the product may fall and cause injury to persons or damage the product.</p>
<p>■ Always detach the Lid and Reflector Panel before removing the Water Tray. Opening or detaching the Lid without the Water Tray in place may cause the product or Lid to fall backward, and is dangerous.</p>	<p>■ Do not place foods directly on the Heaters to cook. Doing so may cause fire.</p>
	<p>■ Do not cover the Exhaust Duct and Air Duct. Doing so may damage the product.</p>

PARTS NAMES

ACCESSORY:

Food Server

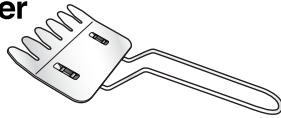

- This food server fits to the grids of the rack and allows serving of fish and other foods without breaking them.
- Please see pg.10 on how to assemble the food server.

Catalytic Filter

- Reduces smoke and odors.

NOTE

In order to stabilize it during shipment, the Reflector Panel is taped to the Lid on 2 locations (left and right). Please remember to remove them before initial use.

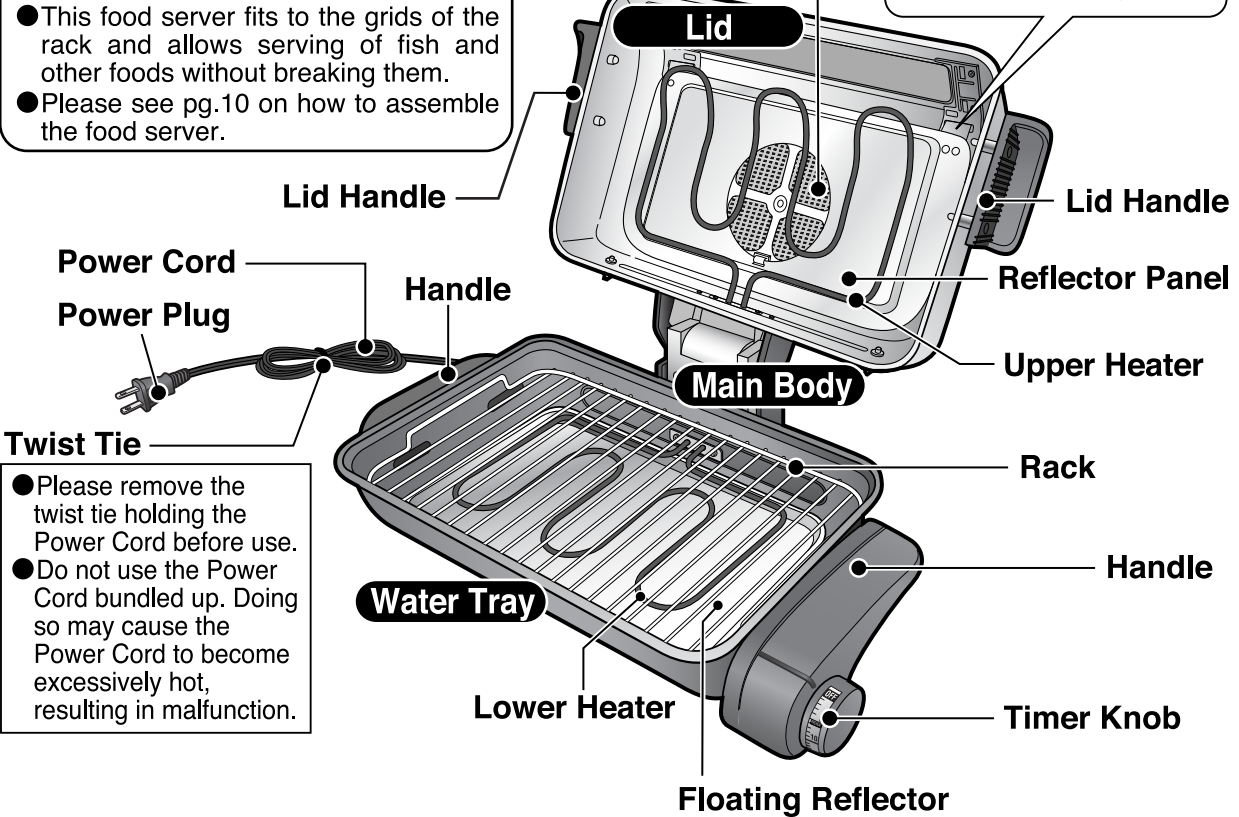

Twist Tie

- Please remove the twist tie holding the Power Cord before use.
- Do not use the Power Cord bundled up. Doing so may cause the Power Cord to become excessively hot, resulting in malfunction.

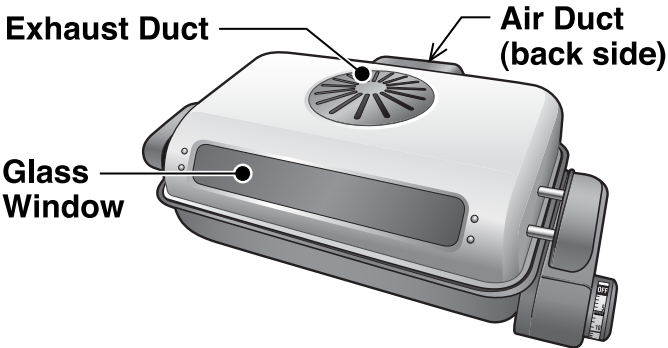

Floating Reflector

The Floating Reflector is floated on the water in the Water Tray. The Floating Reflector reflects the heat from the Lower Heater and reduces evaporation of the water in the Water Tray for better roasting.

KEEP AWAY FROM FLAMMABLES:

- Please keep the following distances between the product and its surroundings to prevent fire.
- Please leave some open space in front of the product as well.

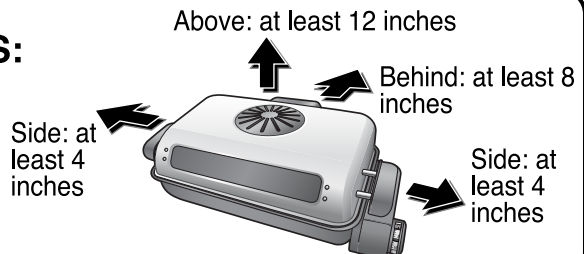

HOW TO USE

Before use

- This product is designed for roasting foods. Please do not use it for any other purposes.
- Please remove all packaging placed inside the product before use.
- You may see light smoke the first time you use the roaster. This is normal. The smoke is harmless and will soon disappear.
- Be sure to check that the Lid and Reflector Panel are securely set (see pg.10 "HOW TO DISASSEMBLE").

1 Insert the Power Plug into an electrical outlet.

Be sure to check that the Timer Knob is at the OFF position.

2 Set the Floating Reflector and the Water Tray.

① Open the Lid and remove the Water Tray.

- Open the Lid gently to prevent the Hinge from breaking.

② Set the Floating Reflector in the Water Tray.

- Be sure to set the Floating Reflector correctly with the hollow side up.

③ Set the Water Tray to the Main Body.

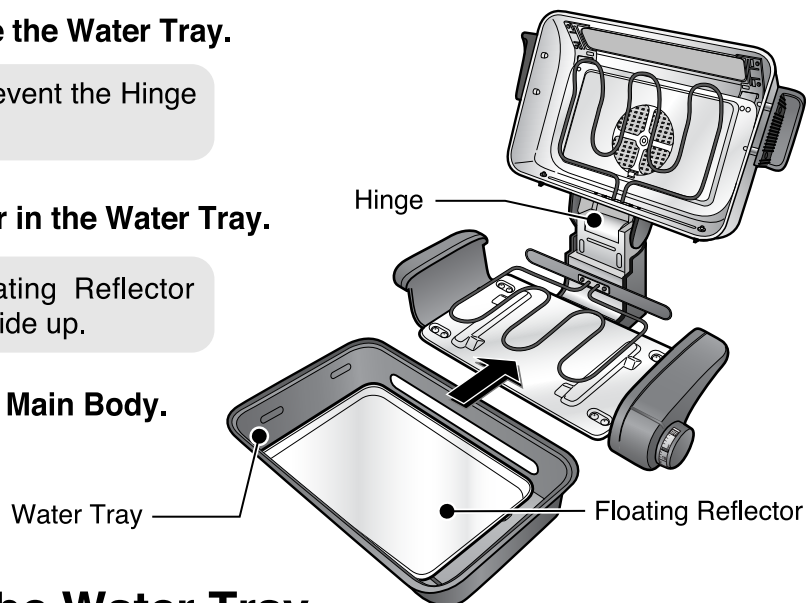

3 Add Water to the Water Tray.

Add about 10 oz. (1-1/4 cups) of water to the Water Tray.

- Be careful not to splash water onto the Lower Heater.
- Be careful not to get the water inside the Floating Reflector.
- A protective device activates when there is no water in the Water Tray, turning off the electric supply to the Heaters. Please wait about 20 minutes to allow the product to cool, then add water to the Water Tray to operate again.

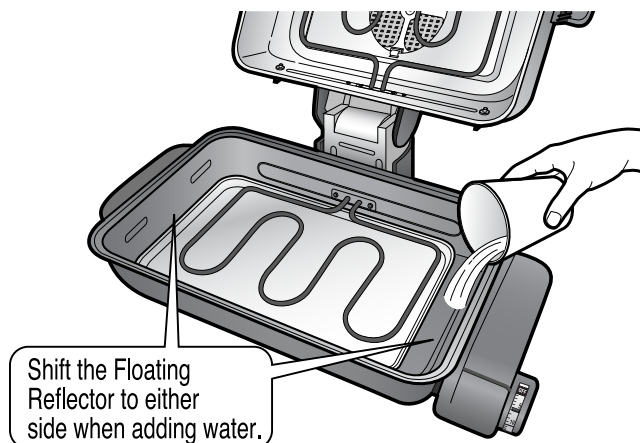

HOW TO USE Cont.

4 Set the Rack in the Main Body.

Flip the rack to adjust the rack height depending on the thickness of the food.

When roasting thickly cut fish/food



When roasting thinly cut fish/food

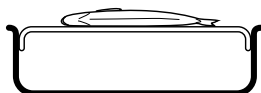

●When roasting thickly cut fish/food, please place it in the center of the Rack to keep it from touching the Upper Heater.

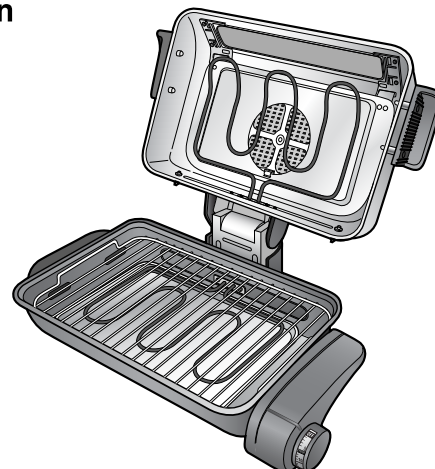

5 Preheat for 5 minutes.

① Close the Lid and turn the Timer Knob to 5 PREHEAT.

② The timer will sound when the preheat cycle is completed.

When setting the timer at less than 10, first turn past 11, then turn back to the desired time.

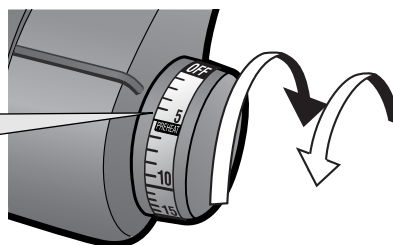

6 Begin roasting.

① Open the Lid and place the fish/food on the Rack.

② Close the Lid and turn the Timer Knob to the desired cooking time.

●Please see the "Suggested Roasting Times" on pg.9.

- Check the roasting progress through the Glass Window.
- Add more water to the Water Tray if it has evaporated while cooking. Add water from the gap between the Water Tray and the Floating Reflector to avoid splashing water onto the Lower Heater.
- Keep your face away from the product when opening the Lid during or immediately after cooking. Hot steam or smoke may arise and cause scalding.
- Be careful not to touch the Heaters and other metal parts when opening the Lid during operation, as they will become very hot. Doing so may cause burns.
- Be careful not to overheat.

To stop roasting, turn the Timer Knob to OFF.

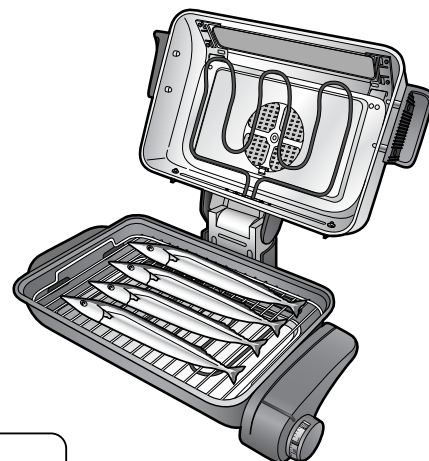

7 Roasting completes.

The timer will sound to alert completion of the roasting cycle.

- ① Open the Lid and remove the fish/food.
- ② Unplug the Power Plug from an electrical outlet.

- Be careful not to touch any part of the product besides the Handles, as they may become very hot.
- Set the Timer shorter when roasting consecutively.

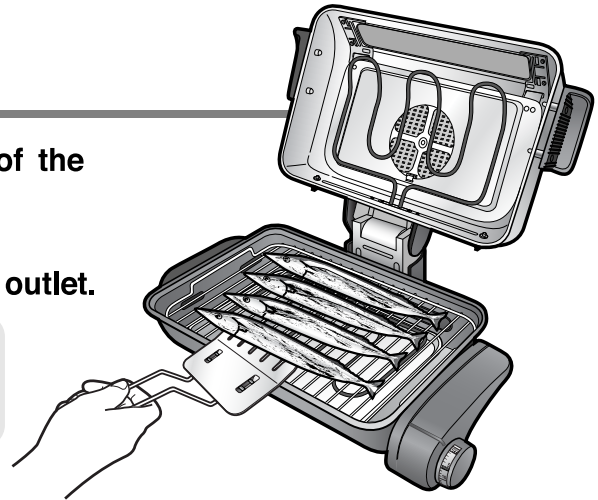

Suggested Roasting Times

Items	Approx. thickness (inches)	Approx. weight of each piece (oz.)	Approx. Cooking time (minutes)
Pacific Saury (Sanma) (2 pcs.)	—	6.35	9~10
Pacific Saury (Sanma) (4 pcs.)	—	6.35	13~15
Open Dried Jack Mackerels (2 pcs.)	—	4.23	8~10
Salmon Steaks (2 pcs.)	1	5.29	10~12
Tilapia (2 pcs.)	$\frac{3}{4}$	2.47	8~10
Tilapia wrapped in foil (2 pcs.)	$\frac{3}{4}$	2.47	13~15
Steaks (2 pcs.)	1	10.58	11~13
Chops (2 pcs.)	$\frac{3}{4}$	4.23	10~12
Hot Dogs (chilled) (8 pcs.)	$\frac{3}{4}$	1.76	5~6
Sausage (chilled) (5 pcs.)	1	3.53	8~10
Chicken (breast/thigh) (1 pc.)	1	12.35	14~16

- ※Cooking times may vary depending on food quantity, size, room temperature and voltage. Adjustments of cooking times by 2 to 3 minutes may need to be made for better results.
- ※Be careful not to allow food to get too close to the Upper Heater as it may become burnt.
- ※For preparing "Tilapia wrapped in foil", wrap each marinated Tilapia in foil. Make sure the aluminum foil does not contact the Upper Heater.
- ※The time indicated above is the cooking time for the sausage of the hot dogs.
- ※When roasting the chicken, place the skin side down.

Roasting Tips

■ How to prevent foods from curling while roasting:

- Use a knife and make cuts on the surface
- Use skewers to hold the food in place

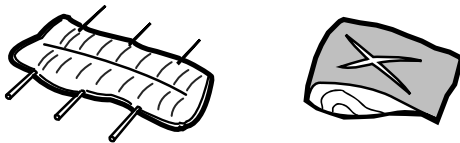

■ How to prevent burning and preserve thin or small parts:

- Salt fish tails and fins or cover with aluminum foil
- Cuts made on the surface of the food give a better appearance after cooking

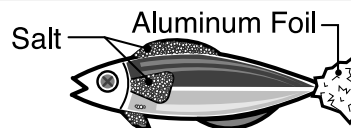

- Greasing the rack after preheating prevents foods from sticking to the rack.
- Keep the thickness of meat to less than 1 inch and the fish to less than 1- $\frac{1}{4}$ inch for better results.

HOW TO DISASSEMBLE

- To put everything back together, perform these instructions in reverse.
- Always remove the Lid and Reflector Panel before removing the Water Tray. (Opening or detaching the Lid without the Water Tray in place may cause the product or the Lid to fall backward, and cause injury to persons or damage the product.)
- Be careful not to spill the water in the Water Tray when removing it.

1. Remove the Lid.

With the Lid closed, turn the Locks on the Lid (2 locations) 90 degrees to unlock, then holding the Handles, slide the Lid forward horizontally as illustrated.

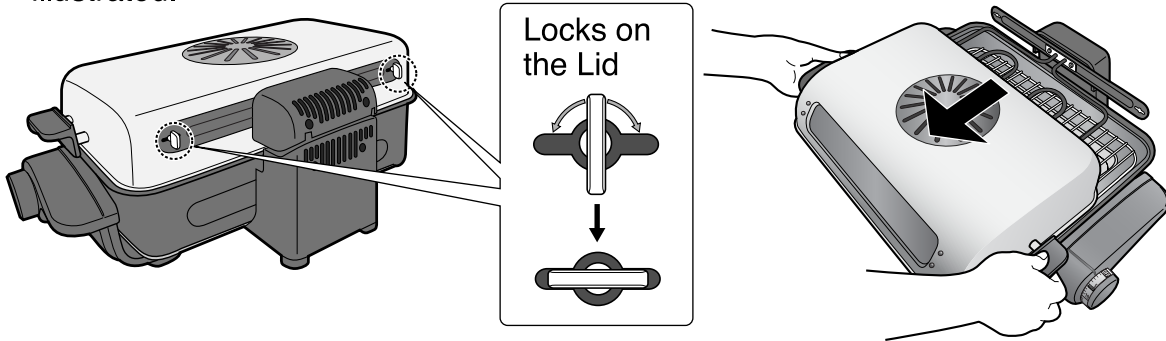

2. Remove the Reflector Panel.

Slide the Reflector Panel as illustrated to remove.

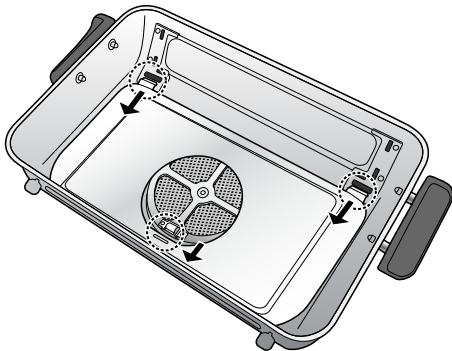

3. Remove the Water Tray.

Slide the Water Tray forward as illustrated to remove.

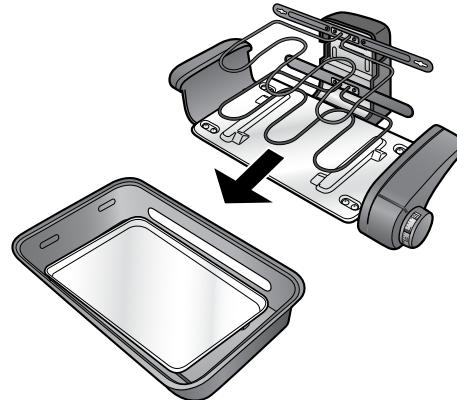

How to Assemble the Food Server:

Hold and squeeze the Handle then insert the edges of the Handle to the holes as illustrated.

- To remove the Handle, squeeze and remove as illustrated.

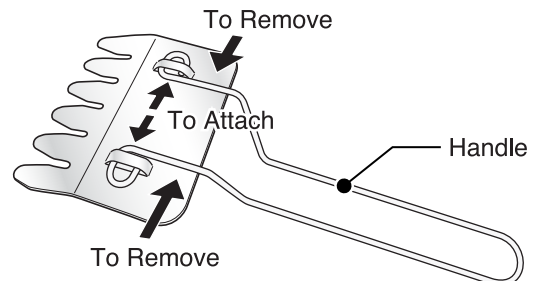

CLEANING AND MAINTENANCE

Always unplug the product from the electrical outlet and allow it to cool completely before cleaning.

NOTES

- Clean after every use. Otherwise, it may cause foods to cook unevenly or damage the Heaters.
- Do not use abrasive cleaners or brushes (nylon/metal). It may damage the surface of the product.
- Do not use thinner, benzene, bleach or any other cleaning agents other than mild kitchen. Doing so may cause corrosion.
- If using a chemically treated cloth, do not wipe the surface of the product strongly or allow the cloth to contact it for an extended period of time. It may damage the surface of the product or cause a chemical reaction.
- Do not use a dishwasher for cleaning or drying.

<p>Lid Reflector Panel Floating Reflector Rack Water Tray Food Server</p>	<p>① Wash with a soft sponge with mild kitchen detergent. ② Rinse and wipe with a dry cloth.</p> <p>Catalytic Filter</p> <ul style="list-style-type: none"> ● Do not scrub the Catalytic Filter strongly with a sponge. (Parts of the sponge may become stuck to the filter and reduce its performance.) ● Dry the Catalytic Filter thoroughly. (If moisture is left in the Catalytic Filter, steam may arise from the Exhaust Duct during operation.)
<p>Main Body Heaters</p>	<p>① Soak a cloth in mild detergent, wring out all excess moisture, and wipe clean. ② Wipe again with a well-wrung cloth (with no detergent). ③ Wipe off any residue with a dry cloth.</p> <ul style="list-style-type: none"> ● Do not wash the Main Body or Heaters or submerge them in water.
<p>Power Cord</p>	<p>Wipe clean with a soft dry cloth.</p>

TROUBLESHOOTING GUIDE

Please check the following points before calling for service.

Condition	Cause	Remedy
Food does not cook. (The Heaters do not heat up.)	<ul style="list-style-type: none"> ●The Power Plug is not plugged in to the electrical outlet securely. 	Plug in securely.
	<ul style="list-style-type: none"> ●The Timer is not set correctly. 	Set the Timer correctly. See pg.8, "HOW TO USE."
	<ul style="list-style-type: none"> ●The water in the Water Tray has evaporated. (The protective device has been activated.) 	Add water to the Water Tray. See pg.7, "HOW TO USE."
There is a flash of fire or smoke inside the roaster or arising from the Exhaust Duct.	<ul style="list-style-type: none"> ●Oil or fat from fish/foods may drip onto the Lower Heater and cause a flash of fire or smoke. Gas created from fat may also cause a flash of fire if the food is rich in fat. If the fire persists, turn the Timer off immediately and unplug the Power Plug. Do not open the Lid or attempt to put out the fire by pouring water. 	
Smoke arises from the Exhaust Duct or around the Lid during operation.	<ul style="list-style-type: none"> ●Oil and fat stuck to the Heaters from previous operations may burn and cause smoke. This does not indicate a malfunction. 	
Smoke arises or it smells.	<ul style="list-style-type: none"> ●You may see light smoke the first time you use the product. This is normal. The smoke is harmless and will soon disappear. 	
	<ul style="list-style-type: none"> ●The inside of the product is dirty. 	Be sure to clean after every use.

SPECIFICATIONS

Model No.	EF-VSC40
Capacity	120V AC 1300W 60Hz
Length of Power Cord	4.6 feet (1.4m)
External Dimensions (inches)	19- ¹ / ₈ (W) x 11- ⁵ / ₈ (D) x 7- ¹ / ₂ (H)
Rack Dimensions (inches)	13- ¹³ / ₁₆ (W) x 8- ⁵ / ₁₆ (D)
Weight	Approx. 10.4lbs (4.7kg)



www.zojirushi.com

EF-VSC ©