



Gourmet d'Expert[®] Electric Skillet

OPERATING INSTRUCTIONS

EP-PBC10

INDEX

IMPORTANT SAFEGUARDS.....	2
PARTS NAMES.....	6
HOW TO USE.....	7
CLEANING AND MAINTENANCE.....	9
REPLACEMENT PARTS.....	9
RECIPES:	
SUKIYAKI.....	10
SHABU-SHABU.....	11
CORN RISOTTO.....	12
STEAK.....	13
TROUBLESHOOTING GUIDE.....	14
SPECIFICATIONS.....	14

IMPORTANT SAFEGUARDS

BASIC SAFETY PRECAUTIONS SHOULD ALWAYS BE FOLLOWED WHEN USING ELECTRICAL APPLIANCES, INCLUDING THE FOLLOWING:

- 1** Read all instructions thoroughly.
- 2** This appliance is not intended for deep frying foods.
- 3** Avoid touching hot surfaces under any circumstances. The handles and knobs are provided for your safety and protection.
- 4** To prevent hazardous operation or electric shock, do not immerse power cord, power plug, or product (except pan and lid) in water or other liquids.
- 5** Close supervision is necessary when the appliance is used by or near children.
- 6** Unplug from outlet when not in use and before cleaning. Allow the appliance to cool before adding or removing parts, and before cleaning the appliance. Make sure appliance is OFF when not in use, before putting on or taking off parts, and before cleaning.
- 7** Do not use or operate the appliance with a damaged cord or plug. If the appliance malfunctions or has been damaged in any manner, unplug the appliance and return it to the nearest authorized service facility or dealer for examination, repair or adjustment.
- 8** The use of accessories or attachments not recommended by the appliance manufacturer may be hazardous or may cause malfunction.
- 9** Do not use outdoors.
- 10** Keep the power cord away from hot surfaces and do not let the cord hang over the edge of tables or counters.
- 11** Do not place the appliance on or near a heated surface such as a gas or electric stove, or in a heated oven.
- 12** Always use extreme caution when moving appliances containing hot contents or liquids.
- 13** Plug the cord into a household electrical outlet. To disconnect, turn the power control to OFF, then remove plug from wall outlet.
- 14** Do not use the appliance for other than intended or specified purposes.
- 15** To reduce the risk of electric shock, use only the supplied pan.
- 16** The plug to the appliance should be attached first before plugging the cord into a wall outlet.

SAVE THESE INSTRUCTIONS

THIS APPLIANCE IS FOR HOUSEHOLD USE ONLY.

This appliance is supplied with a short power cord to reduce the risk of becoming entangled in or tripping over. Extension cords may be used if care is exercised in their use. If an extension cord is used, the marked electrical rating of the cord should be at least as great as the electrical rating of the appliance, and a longer cord should be arranged so that it will not drape over the countertop or tabletop where it can be pulled on by children or tripped over unintentionally.

This appliance has a polarized plug (one blade is wider than the other). To reduce the risk of electric shock, this plug was designed to fit into a polarized outlet in only one direction. If the plug does not fit fully into the outlet, do not attempt to force it or modify it in any way. Simply reverse the plug and insert. If it still does not fit, contact a qualified electrician.

IMPORTANTES MESURES DE SÉCURITÉ

LORS DE L'UTILISATION D'APPAREILS ÉLECTRIQUES, SUIVEZ LES PRÉCAUTIONS DE BASE SUIVANTES:

- 1** Lisez bien toutes les instructions.
- 2** Cet appareil n'est pas conçu pour la grande friture des aliments.
- 3** Ne touchez pas les surfaces qui peuvent être chaudes. Utilisez les poignées ou les boutons. N'obtenez en aucun cas l'orifice d'échappement de la vapeur.
- 4** Pour éviter les chocs électriques, n'immergez jamais le cordon électrique ou la prise, ou encore l'autocuiseur à riz (à l'exception de la marmite située à l'intérieur) dans l'eau ou dans tout autre liquide.
- 5** Soyez vigilants lorsque les enfants utilisent l'appareil ou se trouvent à proximité.
- 6** Débranchez l'appareil après usage ou avant de le nettoyer. Laissez l'appareil refroidir avant d'en retirer ou d'y insérer les accessoires et avant de le nettoyer. Assurez-vous que l'appareil est sur OFF lorsque vous ne vous en servez pas, avant d'en retirer ou d'y insérer les accessoires détachables ou encore avant de le nettoyer.
- 7** N'utilisez pas l'appareil avec une prise ou un cordon électrique endommagé. Ne vous servez pas d'un appareil qui pour une raison ou une autre fonctionne mal. Emportez l'appareil chez le réparateur ou le vendeur le plus proche en vue d'un contrôle ou d'une réparation.
- 8** L'utilisation d'accessoires non recommandés par le fabricant est susceptible d'entraîner des accidents.
- 9** N'utilisez pas l'appareil à l'extérieur.
- 10** Ne laissez pas le cordon électrique pendre par-dessus le bord d'une table ou d'un comptoir et assurez-vous qu'il n'est pas en contact avec une surface chaude.
- 11** Ne placez pas l'appareil près d'une surface chaude telle qu'un brûleur à gaz allumé, une plaque électrique, un poêle ou encore dans un four en train de chauffer.
- 12** Soyez très prudent lorsque vous déplacez l'appareil contenant un liquide ou un aliment chaud.
- 13** Branchez le cordon dans une prise domestique. Avant de débrancher l'appareil, placez-le sur la position ARRET puis retirez la fiche de la prise murale.
- 14** N'utilisez pas l'appareil pour d'autres fonctions que celles auxquelles il est destiné.
- 15** Pour minimiser les risques de chocs électriques, n'utilisez que la marmite interne fournie avec l'appareil.
- 16** Veuillez d'abord relier le cordon d'alimentation à l'appareil avant de brancher la fiche dans une prise murale.

CONSERVEZ CES INSTRUCTIONS

CET APPAREIL EST UNIQUEMENT À USAGE DOMESTIQUE.

L'appareil est équipé d'un cordon court afin de réduire les risques d'enchevêtrement ou de chutes sur le cordon. Des rallonges peuvent être utilisées à condition que toutes les précautions soient prises lors de leur utilisation.

Si vous vous servez d'une rallonge, sa puissance électrique indiquée devra être égale ou supérieure à celle de l'appareil; Le cordon devra être arrangé de manière à ce qu'il ne pende pas depuis le haut d'un comptoir ou d'une table où il serait à portée de main des enfants et où il occasionnerait des accidents dus à une chute ou à un enchevêtrement. L'appareil a une prise polarisée (l'une des lames est plus large que l'autre). Pour réduire les risques de chocs électriques, la prise s'insère dans un seul sens à l'intérieur d'une prise murale polarisée. Si la prise ne s'adapte pas correctement dans la prise murale, retournez-la. Si elle ne s'adapte toujours pas, contactez un électricien spécialisé. Ne cherchez en aucun cas à modifier la prise.

IMPORTANT SAFEGUARDS Be sure to follow the instructions.



● These WARNINGS and CAUTIONS are intended to protect you and others from personal injury and household damage. To ensure safe operation, please follow carefully.



 **WARNINGS** Indicates risk of serious injury. ※1



 **CAUTIONS** Indicates risk of injury or property damage if mishandled. ※2 ※3

※1 Serious injury includes loss of eyesight, burns (high and low temperature), electric shock, bone fractures, toxic reactions as well as other injuries severe enough to require medical care or extended hospitalization.

※2 Injury indicates physical damage, burns or electric shock not severe enough to require medical care or extended hospitalization.

 **CAUTIONS**  Indicates a warning or caution. A specific caution is indicated inside or near the triangle by sentences or illustrations.















 **PROHIBITED**  Indicates a prohibited operation. A specific prohibited operation is indicated inside or near the circle by sentences or illustrations.

 **INSTRUCTIONS**  Indicates a requirement or instruction that must be followed. A specific instruction is indicated inside or near the circle by sentences or illustrations.

※3 Property damage indicates material damage towards a home, furniture, or pets and animals.

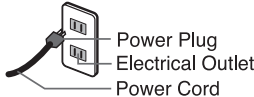









*Keep this Operating Instructions readily available for users to easily refer to at any time.

*The illustrations used in this Operating Instructions may vary from the actual product you have purchased.

 WARNINGS	
 Do not modify the product. Only a repair technician may disassemble or repair this unit. Attempting to do so may cause fire, electric shock or injury. Make any repair inquiries to Zojirushi Customer Service.	 Do not allow the prongs of the Appliance Plug to become soiled with dust or come into contact with any metal objects. This may cause electric shock, short circuit or fire.
 Do not immerse the product in water or splash it with water. Doing so may cause short circuit or electric shock.	 Use only an electrical outlet rated at 15 amperes minimum, and do not plug other devices into the same outlet. Plugging other devices into the same outlet may cause the electrical outlet to overheat, resulting in fire.
 Do not plug or unplug the Power Cord if your hands are wet. Doing so may cause electric shock or injury.	 Insert the Power Plug completely and securely into the electrical outlet. A loosely inserted Power Plug may cause electric shock, short circuit, smoke or fire.
 Do not use this product for deep frying. Doing so may cause fire.	 Stop using immediately if you notice any of the following symptoms indicating a malfunction or breakdown. Continued use of the product may cause smoke, fire, electric shock or injury. <ul style="list-style-type: none"> • The Power Plug or Power Cord has become very hot. • The Power Cord is deeply damaged or deformed. • The electricity turns on and off when the Power Cord is touched or moved. • There is a burning smell. • You feel a tingle or slight electrical shock. • The product does not operate even though the Control Lever is turned on. • The Operation Light does not turn off even though the Control Lever is turned to OFF. etc. If you notice any of the above symptoms, unplug the product immediately and contact the store where you purchased it or Zojirushi Customer Service for check-ups and/or repairs.
 Do not use a power source other than 120V AC. Use of any other power supply voltage may cause fire or electric shock.	
 Do not use the product if the Power Plug or Power Cord is damaged or if the Power Plug is loosely inserted into the electrical outlet. Doing so may cause electric shock, short circuit or fire. 	
 Do not damage the Power Cord. Do not bend, pull, twist, fold, or attempt to modify the Power Cord. Do not place it on or near high temperature surfaces or appliances, under heavy items or between objects. A damaged Power Cord can cause fire or electric shock.	
 Do not allow children to use the product unsupervised. Keep it out of the reach of infants. Children are at risk of burns, electric shock or injury.	 This product is not intended for use by persons (including children) with reduced physical, sensory or mental capabilities, or lack of experience and knowledge, unless they have been given supervision or instruction concerning use of the product by a person responsible for their safety. Children should be supervised to ensure that they do not play with the appliance.
 Do not allow infants or children to put the Appliance Plug in their mouth. Doing so may cause electric shock or injury. Take special precautions with children and infants.	



CAUTIONS

 <p>Do not touch hot surfaces during or immediately after use. Touching hot surfaces may cause burns.</p>	 <p>Do not place or use the product on unstable surfaces or on surfaces that are vulnerable to heat. Doing so may cause fire.</p>
 <p>Unplug the Power Plug from the outlet when the product is not in use. Leaving the Power Plug in an outlet may cause the insulation to become damaged, resulting in electric shock, short circuit or fire.</p>	 <p>Do not directly heat canned or bottled foods as the can or bottle may explode and cause burns or injury.</p>
 <p>Always unplug the product by holding the Power Plug, not by pulling the Power Cord. Pulling the Power Cord to unplug the product may cause electric shock, short circuit or fire.</p>	 <p>Do not use the product near walls, furniture or beneath shelving. Steam or heat may damage, discolor or deform walls, furniture or shelving.</p>
 <p>Please allow the product to cool down before cleaning. The Pan may cause burns when hot.</p>	 <p>Do not use other Power Cords than the one provided. Do not use the Power Cord for other appliances. Doing so may cause malfunction or fire.</p>
 <p>During preheating or cooking, move birds and small animals that may be sensitive to smoke or smells to other rooms, and open windows or turn on exhaust fans.</p>	 <p>Do not use this product for other than intended purposes.</p>  <p>If the Power Cord is damaged, it must be replaced by an appropriate cord or assembly made available by the manufacturer or its service agent.</p>

IMPORTANT

- **Do not use this product for other than stewing, grilling or steaming foods.**
- **Do not turn the power on without setting the Pan in the Main Body. Doing so may cause fire.**
- **Do not leave the Heating Plate with foreign objects attached. It may become stuck to the plate and cause rust.**
- **Handle the product gently; otherwise it may cause malfunction or breakdown.**
- **Please follow these Instructions to ensure extended use and for the protection of the Pan's nonstick coating:**
 - *Do not use metal spatulas. Doing so may damage the surface.
 - *Do not scratch the Pan with sharp objects such as knives and forks.
 - *Do not cover the product and preheat or preheat it for a prolonged period of time.
 - *Do not use a thinner, benzene, abrasive cleaners and brushes (nylon/metal), bleach or anything that may damage the surface of the product. Doing so may cause deformation, discoloration or scarring of the product.
 - *Always clean the surface and the bottom of the Pan thoroughly after use. Acid (vinegar) or salt contents (sauce, soy sauce or salt) may cause corrosion or the product may not perform well.
 - *Do not use detergents other than dishwashing soap such as chlorine based alkaline detergents or those containing acidic ingredients. Doing so may cause corrosion.
 - *Do not leave cooked foods in the Pan. Doing so may cause rust.
- **Please follow these instructions to avoid breakage of the glass Lid:**
 - *Do not cool it down too fast.
 - *Do not drop or apply strong impact.
 - *Do not place directly on fire.
- **Do not use the Pan directly on the stovetop burner for other than preparing stew-type menus.**
Doing so may cause the nonstick coating to peel off, corrode, or cause the Pan to deform or discolor.

PARTS NAMES

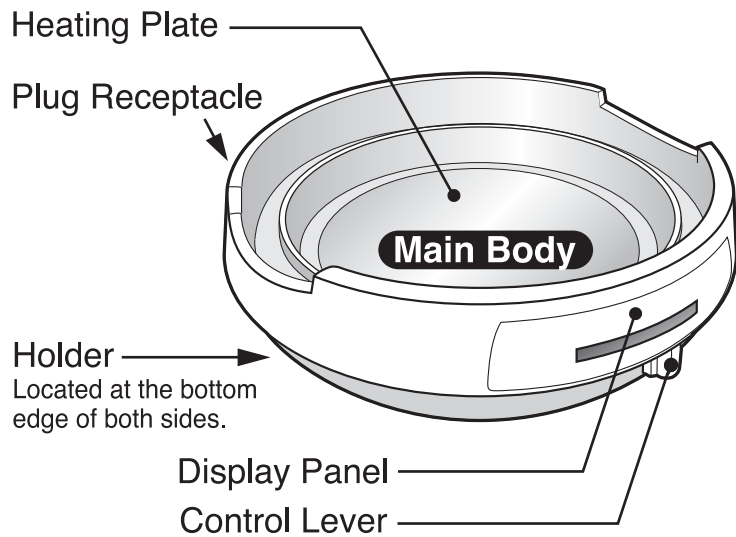
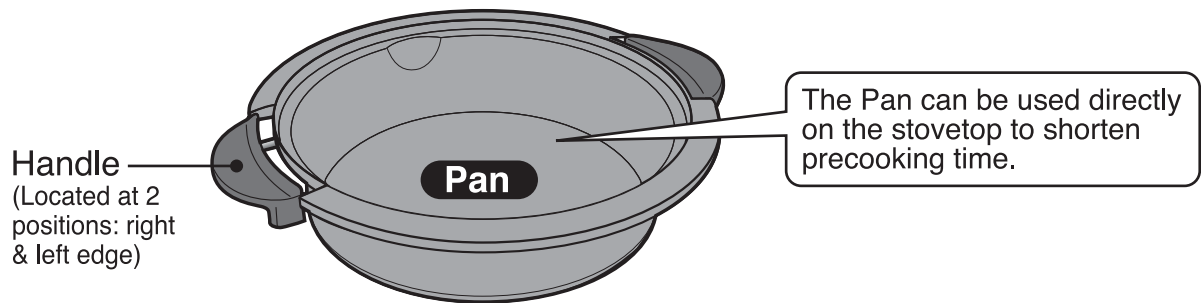
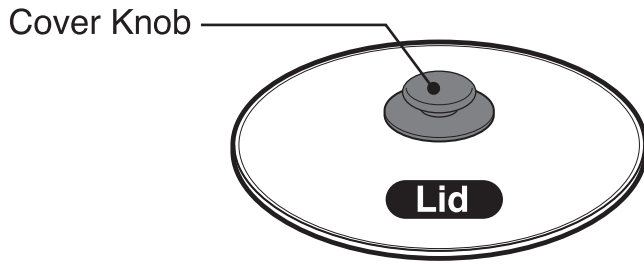

Power Cord

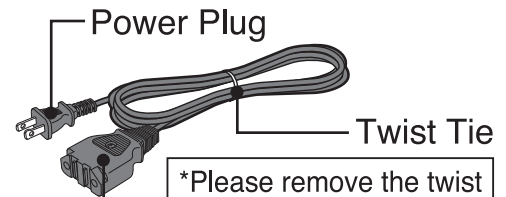

*Please remove the twist tie holding the Power Cord before use.
*Do not use the Power Cord bundled up. Doing so may cause the Power Cord to become excessively hot, resulting in malfunction.

Appliance Plug

Control Panel

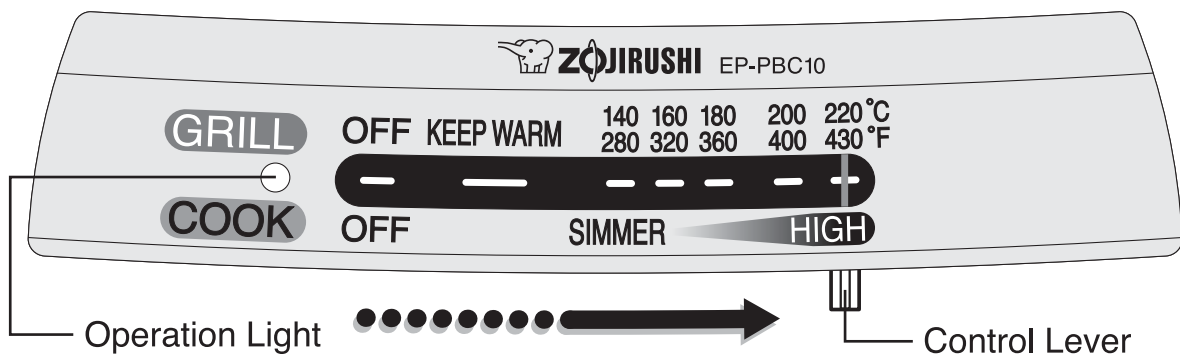

HOW TO USE HOW TO PREPARE

① Set the Pan on the Main Body.

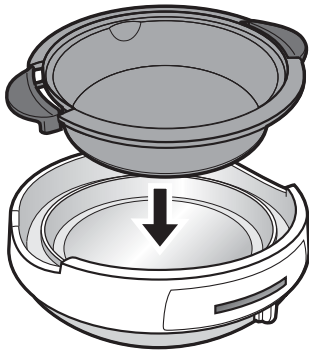

② Turn the Control Lever to OFF and plug in the Power Cord.

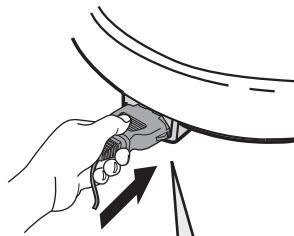

Be sure that the Appliance Plug is clean and free from any foreign objects.

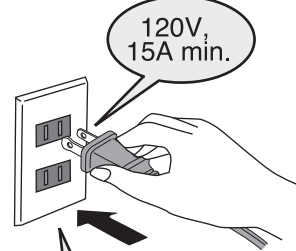

Be sure to insert the Power Plug into the electrical outlet securely.

*Be sure to wipe off all moisture on the Heating Plate and on the bottom of the Pan. (Moisture or water may decrease the product's ability to heat or cause malfunction.)

*Set the Pan securely. Make sure it is not slanted.

■ Cooking Tips



Precook stew-type menus directly on the stovetop burner in the Pan:

The Pan can be used directly on the stovetop burner for quicker heating and preparation.

Do not heat the Pan empty on stovetop burner.

(Do not use the Pan on an induction heater or cooktop.)

*Adjust the flame to the Pan size. The Handles may become burnt or deform if the flames are too strong.

*Do not use the Pan directly on the stovetop burner for other than preparing stew-type menus (such as sizzling, grilling or sautéing).

*To prevent burns, always use oven mitts when holding the Handles as they may become hot.

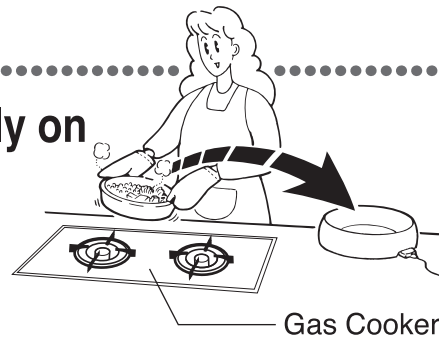

Utilize the Lid:

The surface temperature of the Pan can become 68-86°F higher when the Lid is covered.

*Sizzling and steaming menus (such as frying dumpling, hamburger, steak, fried egg, etc.) can be cooked faster and softer.

*Water or broth will boil faster.

Be careful when removing the Lid:

*Steam may arise from the gap between the Lid and the Pan.

*Hot oil may sputter from the gap between the Lid and the Pan when grilling steaks.

HOW TO USE HOW TO COOK

Cooking in the Pan:

Ideal for cooking hot pots or stews

- 1) Pour water or soup stock in the Pan and cover the Lid.
- 2) Adjust the Control Lever to HIGH. The Operation Light will turn on.
- 3) When the water or soup stock reaches a boil, add ingredients and begin cooking.

Power guidelines for pot and stew menus:

Power	Menus
SIMMER ↑ ↓ HIGH	<p><i>Yose-nabe</i> (Seafood, chicken, tofu, noodles, and vegetables cooked in stock)</p> <p><i>Chanko-nabe</i> (Mixture of meats and vegetables cooked in a pot favored by Japanese Sumo wrestler)</p> <p><i>Shabu Shabu</i></p> <p><i>Yudofu</i> (Boiled <i>tofu</i> cooked in stock)</p> <p><i>Oden</i> (Vegetables and fish cakes cooked in stock)</p> <p><i>Sukiyaki</i></p>

Ideal for grilling and sautéing

- 1) Adjust the Control Lever to the preferred temperature and preheat while the Lid uncovered.
(The Operation Light will turn on and the product begins operating.)
- 2) Begin cooking when preheating completes.

Temperature guidelines for grilling and sautéing:

Power	Menus
430°F 220°C	<i>Yaki-niku</i> (BBQ beef), Fried noodles, Steaks and <i>Sukiyaki</i> etc.
400°F 200°C	<i>Okonomi-yaki</i> (Japanese pancakes) etc.
360°F 180°C	<i>Gyoza</i> (grilled dumplings) etc.
320°F 160°C	Pancakes etc.
280°F 140°C	Crepes, Thin omelets etc.
KEEP WARM	Keeping foods warm at the optimum temperature

Estimated preheat time:

About 8 minutes

*The above temperatures are estimated surface temperatures of the Pan when uncovered.

- Use hot water (not water) to steam and finish grilling *Gyoza* (grilled dumplings).
- When keeping food warm, turn the Control Lever to KEEP WARM.
- You may hear some noise or small clicking sounds during use. This is due to the expansion of the Main Body by the heat and does not indicate a malfunction.

- You may notice that the Operation Light turns on and off during preheat and cooking. This is due to the product controlling the temperature and does not indicate a malfunction.
- You may notice some smell or smoke emitting from the product at initial use, but this is normal and does not indicate a malfunction.

AFTER USE...

- 1) Turn the Control Lever to OFF.
- 2) Unplug the Power Plug and the Appliance Plug.

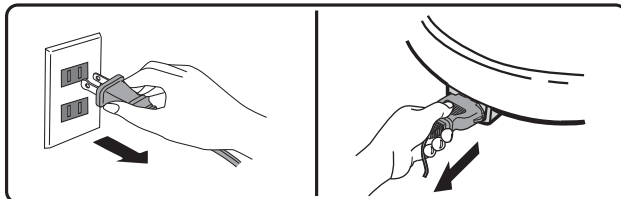

*Be sure to unplug the product by holding the Power Plug, not by pulling the Power Cord.

*Be sure to unplug the Power Cord after every use.

*Please allow the product to cool down before cleaning (for about 40 minutes after cooking).

CLEANING AND MAINTENANCE

Be sure to clean thoroughly after every use. Leaving burnt foods on the Pan may cause scorching, and will become difficult to remove.

● Be sure to unplug the Power Plug and allow the Product to cool down before cleaning.

<p>Lid Pan</p>	<p>1) Wash with a soft sponge. To wash thoroughly, use a dishwashing soap. 2) Wipe clean with a dry cloth after rinsing. *Allow the Pan and Lid to cool before cleaning. *Soak the Pan in warm water if food becomes stuck, then wash with a soft sponge. *Rinse the Lid thoroughly to ensure that there is no dishwashing soap remaining. The Lid may discolor if alkaline-based detergent is used. *After cleaning the Pan, wipe thoroughly with a dry cloth, set in the Main Body and turn the power on to allow it to dry completely. Be sure not to overheat the Pan. After the surface of the Pan is completely dry, apply a thin layer of vegetable oil to protect the surface.</p>
<p>Heating Plate</p>	<p>Soak a cloth in hot water, wring out all excess moisture, and wipe clean. *If any objects are stuck to the Heating Plate, lightly polish them off with sand paper of about No.400 after dipping in water. *Do not splash it with water or soak in water. Doing so may cause breakdown.</p>
<p>Main Body</p>	<p>Clean and wipe with a cloth soaked in water and wrung well.</p>
<p>Power Cord (Appliance Plug · Power Plug)</p>	<p>Wipe it clean with a soft dry cloth.</p>

Do not use the following:

- *Dishwasher (Doing so may cause discoloration)
- *Abrasive cleaners, scouring powders, nylon or steel brushes (These may cause deformation, discoloration and scratches)
- *Detergents other than mild dish liquid such as chlorine based alkaline detergents or acidic detergents (They may cause corrosion)

Wipe thoroughly with a dry cloth after every cleaning.

REPLACEMENT PARTS

*Please replace damaged parts for optimum performance.

*When replacing parts, please check the model number and the parts name beforehand, then contact the store where you purchased the product or Zojirushi Customer Service.

Zojirushi Customer Service
1-800-733-6270
www.zojirushi.com

Parts Names	Parts Number
Lid	BG311001R-00
Pan	7190730001-00

RECIPES

NOTE

The measurements used in these Recipes:

- 1 Cup = approx. 8 oz.
- 1 Tablespoon = 0.5 oz.
- 1 teaspoon = 0.2 oz.

SUKIYAKI

HIGH ~ SIMMER



Ingredients (4 servings):

1 lb. thinly sliced beef loin
Beef tallow
1 pack *Tofu*
1/2 lb. *Ito Konnyaku*
2 stalks green onions
8 fresh *Shiitake* mushrooms

1 bunch *Shungiku* (garland chrysanthemum)
1/4 Chinese cabbage
1 onion
4 eggs

Seasonings:

Soy sauce
Mirin
Sugar

How to cook:

- 1) Cut the beef into bite size pieces. Cut *Tofu* into large blocks. Lightly boil *Konnyaku*, drain and cut to preferred length. Cut green onion into bite-size length. Cut off the bottom of the *Shiitake* and *Enoki* mushrooms. Cut *Shungiku* and Chinese cabbage in 1-1/2 to 2 inch strips and cut onion into large pieces.
- 2) Set the Control Lever to **HIGH**. When the Pan heats up, melt the beef tallow and lightly stir-fry half the beef. Add some vegetables and continue to stir-fry.
- 3) Add soy sauce, *Mirin* and sugar to taste. Then add half of the rest of the ingredients and continue to cook. Once they are cooked through, dip them into a beaten egg and enjoy. As you eat, continue adding ingredients and seasonings.

*Adjust the power between **HIGH** and **SIMMER** to change the cooking temperature.

RECIPES Cont.

NOTE

The measurements used in these Recipes:

- 1 Cup = approx. 8 oz.
- 1 Tablespoon = 0.5 oz.
- 1 teaspoon = 0.2 oz.

SHABU-SHABU

HIGH ~ SIMMER



Ingredients (4 servings):

8 cups water
1 to 1-1/2 lbs. beef or pork, thinly sliced
Shabu-Shabu sauce (available in Asian markets)

Other ingredient options:

Green onions (or welsh onion)
Chinese cabbage
Fresh *Shiitake* mushrooms
Shirataki (*Konnyaku* noodles)

How to cook:

- 1) Thinly slice green onions diagonally and cut Chinese cabbage into 1-1/2 to 2 inches strips. Cut off the hard part at the bottom of the *Shiitake* mushrooms. Run *Shirataki* in boiling water and cut into 3-4 inches length.
- 2) Add water in the Pan, cover the Lid and turn the Control Lever to **HIGH**.
- 3) Once the water begins to boil, add some of the vegetables, and when it begins to boil again, take a slice of the meat and swirl it in the boiling water to cook. Dip in the *Shabu-Shabu* sauce to enjoy.

*Adjust the power between **HIGH** and **SIMMER** to change the cooking temperature.

RECIPES Cont.

NOTE

The measurements used in these Recipes:

- 1 Cup = approx. 8 oz.
- 1 Tablespoon = 0.5 oz.
- 1 teaspoon = 0.2 oz.

CORN RISOTTO

HIGH ~ **SIMMER**



Ingredients (2-3 servings):

5-1/2 oz. long grain rice
1/4 onion
1 cup corn (canned or frozen)
3 cups soup stock (chicken broth, etc.)
Salt and pepper
Olive oil

2 tsp. chopped parsley
2-5 Tbsp. grated (parmesan) cheese

☆Indica rice (long grain) is ideal for this menu.

How to cook:

- 1) Rinse rice and drain. Finely chop onion.
- 2) Turn the Control Lever to **HIGH**. When preheating completes, add olive oil and stir-fry the onions from Step 1 above and then the rice.
- 3) When the rice turns translucent, add the soup stock and cover the Lid. Turn the Control Lever to **SIMMER** once it begins to boil.
- 4) After about 15 minutes, add corn and turn the Control Lever to **HIGH** again. When it reaches a boil, add salt and pepper to taste.
- 5) Serve in a bowl and garnish with parsley and grated cheese.

RECIPES Cont.

STEAK

430°F (220°C)

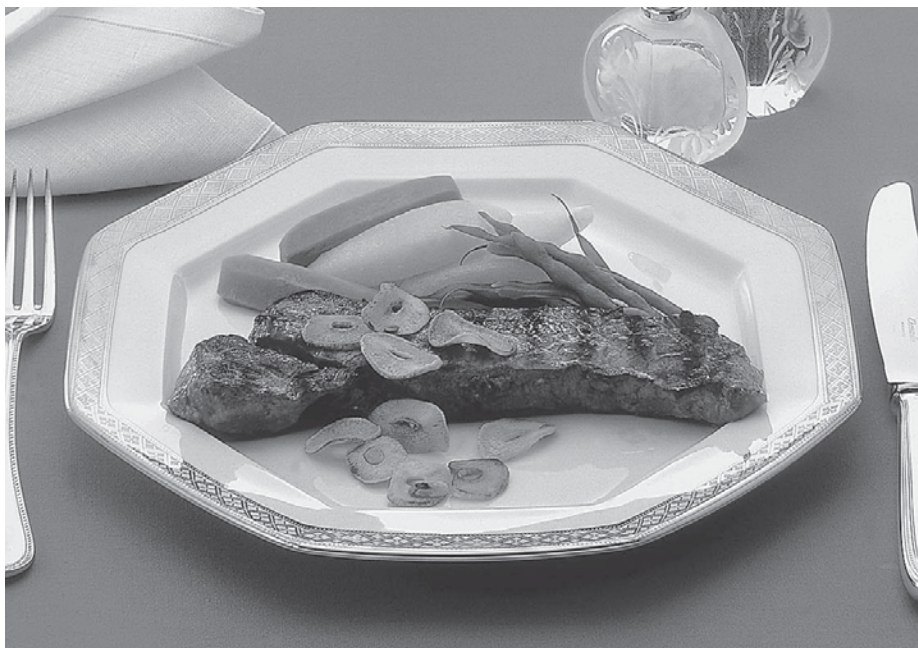

Ingredients (4 servings):

4 cuts sirloin or fillet steak
Salt and pepper
Vegetable oil
◆Garlic slices (optional)

Garnish:

Carrots, potatoes, kidney beans
(Broccoli and cauliflower also make great garnishes)

How to cook:

- 1) Prepare the garnish first by boiling the carrots, potatoes and kidney beans.
- 2) Turn the Control Lever to **430°F(220°C)**. When preheating completes, heat vegetable oil. Toast garlic slices until they turn golden brown and reserve. Flavor the steak with salt and pepper and place on the Pan. Once the steak becomes golden brown, turn it over and cover the Lid.
- 3) Grill the meat until your preferred finish. Serve on a warmed plate along with the garnish. Garnish steak with roasted garlic.

*Be careful when uncovering the Lid during cooking as oil may sputter.

TROUBLESHOOTING GUIDE

Please check the following points before calling for service.

Problems	● Cause (Points to check)
The Pan does not get warm (power does not turn on).	*The Power Plug is not plugged in. → Connect the Power Plug.
	*The Appliance Plug is not connected properly. → Connect the Appliance Plug properly.
Does not cook well.	*Preheating was insufficient. → Preheat well before beginning to cook (approx. 8 minutes).
It takes too long to boil or it does not boil.	*Water or broth was boiled without covering the Lid. → Covering the Lid when cooking helps liquids come to a boil quicker.
	*The temperature of the water or broth was lowered by adding too much ingredients at one time. → Add ingredients gradually.
	*Heating the water or broth directly on a stovetop burner will take less time.
	*The Heating Plate is soiled, and heat is not conducting well to the Pan. → Clean the Heating Plate. (See pg. 9 "CLEANING AND MAINTENANCE")
Food scorches or burns too much.	*The Pan is soiled (food is stuck on its surface). → Clean the Pan. (See pg. 9 "CLEANING AND MAINTENANCE")

SPECIFICATIONS

Model No.	EP-PBC10
Rating	AC120V 60Hz
Electric Consumption	1,300W
Length of the Power Cord	6.3 feet (1.9m)
External Dimensions (approx. inches)	15.2 (W)×13.8 (D)×7.7 (H)
Weight	approx. 8.9 lbs.
Temperature Control	Keep Warm ~430°F (220°C)

Memo Please use as notations.

A large rectangular area with a dashed horizontal line for writing.



www.zojirushi.com

EP-PBC © ®