



USA CAN

MICOM RICE COOKER & WARMER OPERATING INSTRUCTIONS

NS-WTC10

INDEX

IMPORTANT SAFEGUARDS.....	2
ABOUT THE INNER COOKING PAN.....	5
PARTS NAMES AND FUNCTIONS	6
TIPS FOR DELICIOUS RICE.....	8
HOW TO SET THE CLOCK	9
SOUND SIGNALS AND HOW TO CHANGE THEM.....	9
COOKING RICE:	
BASIC COOKING STEPS	10
ESTIMATED COOKING TIME.....	11
TIPS TO COOKING VARIOUS RICE MENUS	12
USING THE TIMER TO COOK RICE:	
USING THE TIMER	13
KEEPING RICE WARM:	
REGULAR KEEP WARM AND EXTENDED KEEP WARM....	14
HOW TO USE THE STEAM FUNCTION	16
RECIPES:	
HAND-ROLLED SUSHI	18
MIXED RICE	18
AVOCADO & TUNA BOWL	19
MIXED BROWN RICE	19
CLEANING AND MAINTENANCE	20
REPLACEMENT PARTS	21
TROUBLESHOOTING GUIDE.....	22
ERROR DISPLAYS AND THEIR MEANINGS	25
SPECIFICATIONS	26

IMPORTANT SAFEGUARDS

BASIC SAFETY PRECAUTIONS SHOULD ALWAYS BE FOLLOWED WHEN USING ELECTRICAL APPLIANCES, INCLUDING THE FOLLOWING:

- 1** Read all instructions thoroughly.
- 2** Avoid touching hot surfaces and do not close or clog the steam vent opening under any circumstances. The handles and knobs are provided for your safety and protection.
- 3** To prevent hazardous operation or electric shock, do not immerse power cord, power plug, or rice cooker (except inner cooking pan) in water or other liquids.
- 4** Close supervision is necessary when the appliance is used by or near children.
- 5** Unplug from outlet when not in use and before cleaning. Allow the appliance to cool before adding or removing parts, and before cleaning the appliance.
- 6** Do not use or operate the appliance with a damaged cord or plug. If the appliance malfunctions or has been damaged in any manner, unplug the appliance and return it to the nearest authorized service facility or dealer for examination, repair or adjustment.
- 7** The use of accessories or attachments not recommended by the appliance manufacturer may be hazardous or may cause malfunction.
- 8** Do not use outdoors.
- 9** Keep the power cord away from hot surfaces and do not let the cord hang over the edge of tables or counters.
- 10** Do not place the appliance on or near a heated surface such as a gas or electric stove, or in a heated oven.
- 11** Always use extreme caution when moving appliances containing hot contents or liquids.
- 12** Plug the cord into a household electrical outlet. To disconnect, press the cancel button, then remove plug from wall outlet.
- 13** Do not use the appliance for other than intended or specified purposes.
- 14** To reduce the risk of electric shock, use only the supplied inner cooking pan.
- 15** The plug to the appliance should be attached first before plugging the cord into a wall outlet.

SAVE THESE INSTRUCTIONS

THIS APPLIANCE IS FOR HOUSEHOLD USE ONLY.

This appliance is supplied with a short power cord to reduce the risk of becoming entangled in or tripping over it. Extension cords may be used if care is exercised in their use. If an extension cord is used, the marked electrical rating of the cord should be at least as great as the electrical rating of the appliance, and a longer cord should be arranged so that it will not drape over the countertop or tabletop where it can be pulled on by children or tripped over unintentionally.

This appliance has a polarized plug (one blade is wider than the other). To reduce the risk of electric shock, this plug was designed to fit into a polarized outlet in only one direction. If the plug does not fit fully into the outlet, do not attempt to force it or modify it in any way. Simply reverse the plug and insert. If it still does not fit, contact a qualified electrician.

IMPORTANT SAFEGUARDS

Be sure to follow these instructions.

These WARNINGS and CAUTIONS are intended to prevent property damage or personal injury to you and others.

■ The degree of danger or damage by the misuse of this product is indicated as follows:

 **WARNING** Indicates risk of serious injury or death.

 **CAUTION** Indicates risk of injury, household or property damage if mishandled.

■ Prohibited or required actions are indicated as follows:

 Indicates a prohibited operation.

 Indicates a requirement or instruction that must be followed.

WARNING

 **Do not modify the Rice Cooker. Only a repair technician should disassemble or repair this unit.** Attempting to do so may cause fire, electric shock or injury. Make any repair inquiries to Zojirushi Customer Service.

 **Do not place your hands or face near the Steam Vent.** Doing so may cause burns or scalding. Take special precautions with children and infants.

 **Do not plug or unplug the Power Cord if your hands are wet.** Doing so may cause electric shock or injury.

 **Do not immerse the Rice Cooker in water or splash it with water.**
Do not pour water directly into the Rice Cooker. Doing so may cause short circuit or electric shock.
Do not allow liquid to come in contact with the Plug Receptacle, Power Plug, Power Cord or Appliance Plug. Doing so may cause short circuit or electric shock.

 **Do not put any metal objects such as pins or wires into the Air Vent or crevices located at the bottom of the Rice Cooker.** Doing so may cause electric shock or malfunction, resulting in injury.
Do not allow children to use the Rice Cooker unsupervised. Keep it out of the reach of infants. Children are at risk of burns, electric shock or injury.



Do not open the Outer Lid or move the Rice Cooker during cooking. Doing so may cause burns.

This Rice Cooker is for cooking rice, keeping rice warm, and steam cooking only.
Do not use for other than intended purposes. Always follow the Operating Instructions, and never cook the following:

- Foods packaged in plastic bags.
 - Foods wrapped in parchment paper, aluminum foil, plastic wrap, etc.
- Doing so may clog the steam exhaust route.

Do not use the Rice Cooker if the Power Cord or Power Plug is damaged or if the Power Plug is loosely inserted into the electrical outlet.

Doing so may cause electric shock, short circuit or fire.

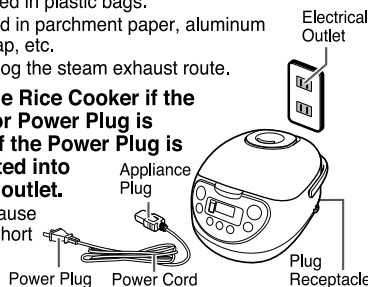

 **Do not damage the Power Cord. Do not bend, pull, twist, bundle or attempt to modify the Power Cord. Do not place it on or near high temperature surfaces or appliances, under heavy items or between objects.**

A damaged Power Cord can cause fire or electric shock.

Do not use a power source other than 120V AC. Use of any other power supply voltage may cause fire or electric shock.

Do not allow the Power Plug to come into contact with steam.

Allowing the Power Plug to come into contact with steam after inserting it into the electrical outlet may cause short circuit or fire. When using on a slide-out table or shelf, place the Rice Cooker in a position where the Power Plug does not come into contact with steam.

 **Insert the Power Plug completely and securely into the electrical outlet.**

A loosely inserted Power Plug may cause electric shock, short circuit, smoke or fire.

Use only an electrical outlet rated at 15 amperes minimum, and do not plug other devices into the same outlet.

Plugging other devices into the same outlet may cause the electrical outlet to overheat, resulting in fire.

If the blades or surface of the Power Plug become soiled, wipe them clean.

A dirty Power Plug may cause fire.

Stop using immediately if you notice any of the following symptoms indicating a malfunction or breakdown.

Continued use of the Rice Cooker under these circumstances may cause smoke, fire, electric shock or injury.

- The Power Plug, Power Cord or Appliance Plug has become very hot.
- The Power Cord is damaged or the electricity turns on and off when touched.
- The body of the Rice Cooker is deformed or unusually hot.
- Smoke is arising from the Rice Cooker or there is a burning smell.
- Some part of the Rice Cooker is cracked, loose or unstable. etc.

If any of the above occurs, unplug the Rice Cooker immediately and contact the store where you purchased it or Zojirushi Customer Service for check-ups and/or repair.

This appliance is not intended for use by persons (including children) with reduced physical, sensory or mental capabilities, or lack of experience and knowledge, unless they have been given supervision or instruction concerning use of the appliance by a person responsible for their safety. Children should be supervised to ensure that they do not play with the appliance.

● The illustrations used in these Operating Instructions may vary from the actual product you have purchased.

IMPORTANT SAFEGUARDS (cont.)

⚠ CAUTION



Do not touch hot surfaces during or immediately after use. Be careful of steam when opening the Outer Lid. Be careful not to touch the Inner Cooking Pan when loosening rice.
Touching hot surfaces may cause burns.

Be especially careful with metal parts such as the Inner Lid Set, Inner Cooking Pan and Heating Plate.

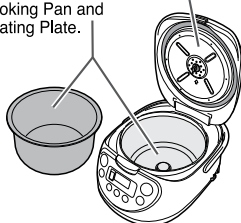

Do not use the Rice Cooker on a slide-out table or shelf with insufficient load capacity.

Doing so may damage the slide-out table or shelf, causing the Rice Cooker to fall, resulting in injury or burns. The slide-out table or shelf should at least have a load capacity of 33 lbs. / 15 kg.

Do not use the Rice Cooker on a surface where the Air Vent located at the bottom of the Rice Cooker can become blocked or covered (such as on paper, cloth, carpet, plastic bag or aluminum sheet).

Doing so may cause breakdown or malfunction.

Do not use other Power Cords than the one provided. Do not use the Power Cord for other appliances.

Doing so may cause malfunction or fire.



Do not touch the Open Button when moving the Rice Cooker.

Doing so may cause the Outer Lid to open, resulting in injury or burns.

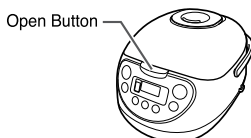

Unplug the Power Plug from the outlet when the Rice Cooker is not in use.

Leaving the Power Plug in an outlet may cause the insulation to become damaged, resulting in burns, injury, electric shock, short circuit or fire.



Please allow the Rice Cooker to cool down before cleaning.

Hot parts such as the Inner Lid, Inner Cooking Pan and heating element may cause burns.

Always unplug the Rice Cooker by holding the Power Plug, not by pulling the Power Cord.

Pulling the Power Cord to unplug the Rice Cooker may cause electric shock, short circuit or fire.

Insert the Appliance Plug into the Plug Receptacle securely.

Otherwise it may cause electric shock, short circuit, smoke or fire.

If the Power Plug, Power Cord or Appliance Plug is damaged, it must be replaced by an appropriate cord or assembly made available by the manufacturer or its service agent.

Do not use the Rice Cooker where it may come into contact with water or near heat sources.
Doing so may cause electric shock, short circuit, or can deform the Rice Cooker.

Do not use cookware other than the provided Inner Cooking Pan or Steaming Basket.

Doing so may cause the inner cooking pan or steaming basket to overheat or the Rice Cooker to malfunction.

Do not use the Rice Cooker near walls or furniture. Allow enough room for steam to escape if using beneath shelving.

Steam or heat may damage, discolor or deform walls, furniture or shelving.

Do not place or use the Rice Cooker on unstable surfaces or on surfaces that are vulnerable to heat.
Doing so may cause injury or fire.

IMPORTANT

When you are finished, be sure to press the CANCEL button to cancel the Keep Warm mode.

Removing the Inner Cooking Pan only will not cancel the Keep Warm mode.

Do not cover the Main Body, especially the Steam Vent, with a cloth or other objects.

Doing so may cause deformation and/or discoloration of the Main Body or Outer Lid.

Do not damage, drop or deform the Inner Cooking Pan.

A damaged Inner Cooking Pan may not cook properly.

Do not operate the Rice Cooker if rice or other matter is stuck on the inside of the Main Body, the outside surface of the Inner Cooking Pan, the Center Sensor or the Heating Plate.

Doing so may burn the rice or otherwise cause imperfect cooking.

Do not cook when the Inner Cooking Pan is empty.

Doing so may cause breakdown of the Rice Cooker or melting of the Steaming Basket.

Do not splash the Rice Cooker with water or place it on top of something wet.

Doing so may cause electric shock or breakdown.

Do not use the Rice Cooker in direct sunlight.

Doing so may cause discoloration of the Rice Cooker.

Do not use the Rice Cooker where its steam may come into contact with other electrical appliances.

The steam may cause fire, malfunction, discoloration or deformation to other electrical appliances.

Always hold the Rice Cooker by the Handle when carrying it. Do not tilt the Main Body.

Doing so may cause the contents to spill.

Clean the Rice Cooker and the surrounding area before using it.

This Rice Cooker is equipped with an Air Vent to improve function and performance, but if dust or insects enter the Air Vent, the Rice Cooker may malfunction. If the Rice Cooker malfunctions due to insects, etc. entering the Air Vent, there will be a charge for repairs.

Do not use the Rice Cooker on top of an induction heating cooker.

Doing so may cause breakdown.

This appliance is intended for household use and similar applications listed below:

- Staff (employee) kitchen area in shops, offices and other working environments.

- * This appliance is not intended for use by many unspecified people for a long period of time.

This appliance must not be used in the following areas:

- Farm houses.
- By clients in hotels, motels and other residential type environments.
- Bed and breakfast type environments.

IMPORTANT SAFEGUARDS (cont.)

ABOUT THE INNER COOKING PAN

In order to use the Inner Cooking Pan for many years to come, please obey the following.

Inner Surface (Nonstick Coating)

The Nonstick Coating can peel off if damaged.

Please take special care to prevent damage and follow these precautions:

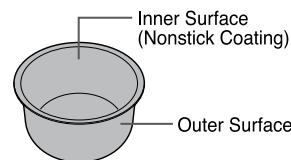

<During Preparation>

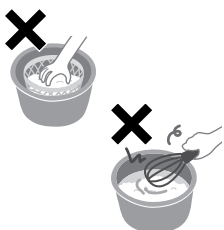

- Remove foreign matter (such as stones) from the rice before cleaning.
- Do not use utensils such as whisks to clean the rice.
- Do not place a metal strainer in the Inner Cooking Pan when cleaning rice.
- Use the Inner Cooking Pan only for this Rice Cooker.

<When Cooking Completes>



- Do not pour vinegar into the Inner Cooking Pan (when making sushi rice).
- Do not use a metal ladle (when serving porridge etc.).
- Do not hit with the Spatula or other utensils (when serving, etc.).

<When Cleaning> → pg. 20

- Do not place utensils or dishes inside the Inner Cooking Pan.
- Do not place in a dishwasher or dish dryer.
- Clean the Inner Cooking Pan immediately after using any seasonings.
- Only use soft cleaning implements such as a sponge when cleaning.



- Do not use such items as thinner, abrasive cleaners, bleach, scrubbing brushes (nylon, metal, etc.), melamine sponges or sponges with a nylon surface.



Nylon Surface

The Nonstick Coating may wear out with use.

- The Nonstick Coating may eventually discolor or peel off. This will not affect the cooking / Keep Warm performances or its sanitary properties, and is harmless to your health.
- If concerned with the peeling of the Nonstick Coating or if the Inner Cooking Pan deforms, please replace it by purchasing a new one. → pg. 21

Outer Surface

- Heat may cause some discoloration, but this does not affect the cooking results.
- The outer surface touches important sensitive sensors. Be careful not to allow it to get dirty or damaged.

PARTS NAMES AND FUNCTIONS

Steam Vent Cap

- Be sure to firmly insert the Steam Vent Cap.
- The Steam Vent Cap will be very hot while cooking and immediately afterward. Be very careful.

Steam Vent

- Steam arising from the vent is very hot while cooking. Please exercise caution.

Steam Vent Cap Receptacle

Open Button

Press the Open Button to open the Outer Lid.

About the Lithium Battery

A lithium battery is installed internally so that even if the Power Cord is unplugged, information such as the current time and Menu settings are saved. The lithium battery will wear out with use. → pg. 25

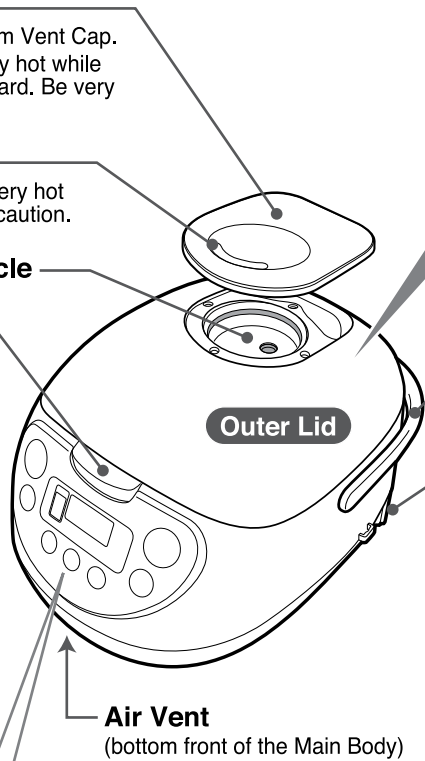

HOW TO CLOSE THE OUTER LID

Push down on the Outer Lid until you hear it click shut.

Press down on the center front edge of the Outer Lid.



- The Outer Lid may open during cooking or Keep Warm mode if it is not closed securely.

Handle

Use the Handle for carrying.

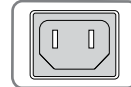

Plug Receptacle

Appliance Plug inserts here.

Power Plug

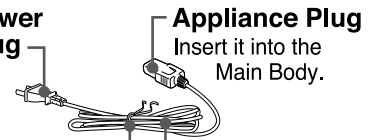

Insert it into the Main Body.

Twist Tie

Power Cord

- Please remove the Twist Tie holding the Power Cord before use.
- Do not use the Power Cord bundled up. Doing so may cause the Power Cord to become excessively hot, resulting in malfunction.

CONTROL PANEL

- Press buttons down firmly.
- The raised dot and dash (●, —) in the center of the START and CANCEL buttons and the Sound Signals are provided for individuals with visual impairment.

Display

- Black lines that may appear on the LCD when wiped with a cloth are caused by static electricity and do not indicate a malfunction. Such lines disappear shortly.

This Display is an example only, and will not appear in actual use.

CANCEL button

- Use to cancel the selected setting or function in operation.

KEEP WARM light

KEEP WARM button

- Use when switching to REGULAR KEEP WARM or EXTENDED KEEP WARM during KEEP WARM mode. → pg. 14

MENU button

- Use to set the menu you will be using. → pg. 10

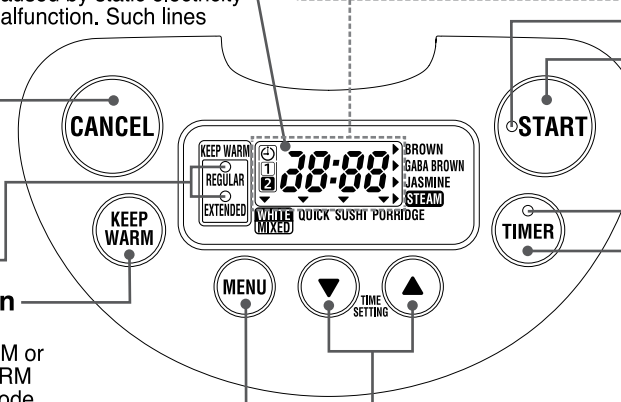

START light

START button

Use this button to initiate cooking or the steam cooking process.

TIMER light

TIMER button

Use when cooking rice using the Timer function. → pg. 13

TIME SETTING button

- Use when adjusting the current time. → pg. 9
- Use when setting the scheduled time for TIMER cooking. → pg. 13
- Use to set the time for steaming. → pg. 16

PARTS NAMES AND FUNCTIONS (cont.)

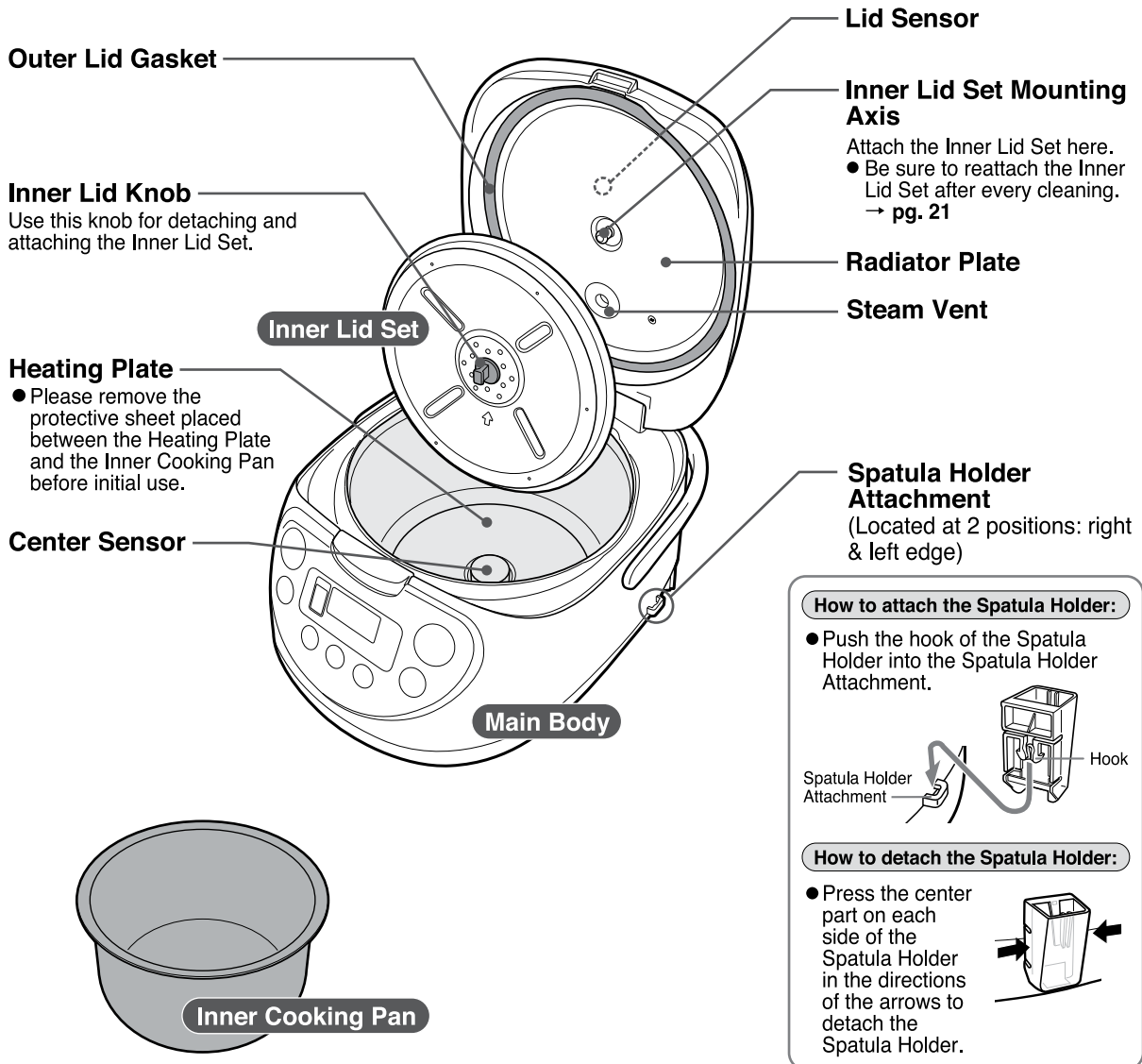

ACCESSORIES			
Spatula 	Spatula Holder 	Steaming Basket 	Measuring Cup (1 Cup = approx. 6.1 oz. / approx. 180 mL)

TIPS FOR DELICIOUS RICE

TIPS FOR COOKING DELICIOUS RICE

● Measure rice accurately

Be sure to use the Measuring Cup provided, as other measuring cups may differ. Level the rice off at the top of the cup to maintain accuracy.

● Clean rice quickly Prepare a bowl to pool water

- ① **Rinse rice...**First, pour plenty of water into the Inner Cooking Pan from the bowl and stir the rice loosely 2-3 times (within 10 seconds) by hand. Drain the water immediately afterwards. Repeat twice.
- ② **Wash rice...**Wash by stirring the rice by hand 30 times (about 15 seconds), pour plenty of water from the bowl and stir the rice loosely again. Drain the water immediately. Repeat this washing process 2-3 times.
- ③ **Rinse rice...**Lastly, pour plenty of water from the bowl and rinse the rice. Repeat twice.

(Complete steps ①-③ within 10 minutes.)



Warning!

Do not clean the rice or adjust the amount of water using hot water (95°F / 35°C or above). Doing so will cause the rice to be cooked improperly.

● Adjust the amount of water accordingly

Type of Rice	New crop	Old crop
Water Adjustment	Reduce water slightly from the normal level	Add a little water to the normal level

- If you add too much water, it may boil over through the Steam Vent.

e.g.: When Cooking 3 Cups of White Rice

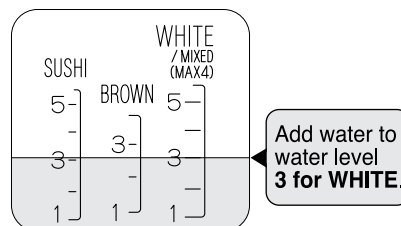

● Do not use strongly alkalinized ionic water

Do not use alkalinized ionic water that is over pH 9. Rice cooked with strongly alkalinized ionic water may appear yellow or become too glutinous.

● Stir and loosen rice immediately after cooking has completed

Doing so releases excess moisture, resulting in rice that is perfectly cooked with a fluffy texture. Loosen the rice within 10 minutes after cooking completes. Not loosening the rice may cause it to clump, become too glutinous or burn.

TIPS FOR USING THE KEEP WARM MODE

● When keeping rice in the Inner Cooking Pan for later consumption, use the Keep Warm mode.

- The rice may develop a foul odor or condensed moisture may fall on the rice, making it sticky, if the Keep Warm mode is cancelled or if left in an unplugged Rice Cooker.

● To prevent the rice from becoming dry or wet, developing an odor or turning yellow, do not use the Keep Warm mode for the following:

- Keeping a small amount of rice warm for long hours.
- Keeping rice warm for more than 12 hours.
- Adding additional rice while keeping rice warm.
- Reheating cold rice.
- Keeping foods other than rice warm such as croquettes, miso soup, or steamed foods.
- Keeping rice warm with the Spatula left inside the Rice Cooker.
- Keeping rice warm when it contains additional ingredients and seasonings (mixed rice, etc.).

● When keeping a small amount of rice warm, gather the rice toward the center of the Inner Cooking Pan.

- As the amount of rice kept warm decreases, the rice may dry or become wet. To minimize this, gather the rice toward the center of the Inner Cooking Pan while keeping warm.



HOW TO SET THE CLOCK

If the clock is inaccurate, set the correct time as shown below.

- The clock is displayed in 24 hours (military time).

e.g.: If the current time is 15:01 but displays 14:56.

- 1 Set the Inner Cooking Pan and plug in the Power Cord.**
→ See step 4 under "BASIC COOKING STEPS" on pg. 10
- 2 Press the ▲ or ▼ button to initiate the Time Setting and adjust the clock to the current time while the time display is blinking.**

- ▲ : Each press advances the time in 1-minute increments.
- ▼ : Each press reverses the time in 1-minute increments.
- Press and hold either button to quickly adjust in 10-minute increments.

- 3 The time display will stop blinking after 3 seconds, indicating the Time Setting is completed.**

If the time display still does not show the current time, repeat Step 2 to readjust the time.

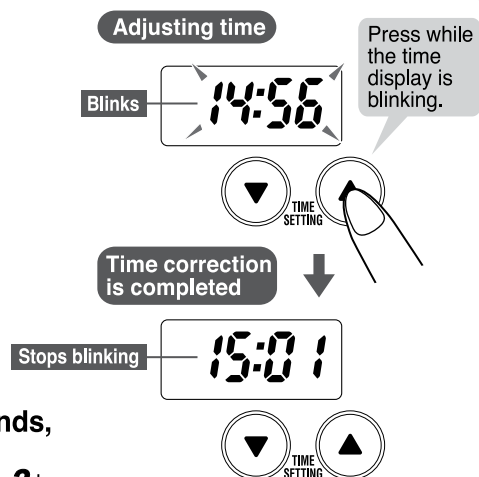

- Although the clock is set before shipment from the factory, certain conditions such as room temperature may cause it to display an inaccurate time.
- If the clock is inaccurate, the cooking will not be completed at the time you set for the Timer.
- The clock cannot be changed during Cooking (Steaming), Regular Keep Warm, Extended Keep Warm, or Timer Cooking.

SOUND SIGNALS AND HOW TO CHANGE THEM

This product includes a melody function that allows you to set a melody to inform you when certain actions occur, such as when cooking (steaming) starts, when Timer operation is finished, and when cooking (steaming) completes. You can also switch the melody to a beep or to silent.

Types of Sound Signals: You can choose the Sound Signals from the following:

Types of Sound Signals and their meanings	Melody:	Beep:	Silent:
Indication	The default setting at the time of shipment from the factory.	Choose this setting to change from a Melody.	Choose this setting to disable the Sound Signal.
Cooking (Steaming) has begun:	"Twinkle, Twinkle, Little Star"	a beep	
Timer is set:	"Twinkle, Twinkle, Little Star"	a beep	
Cooking (Steaming) has completed:	"Amaryllis"	beeps 5 times	no sound

How to change the Sound Signal:

- 1 Set the Inner Cooking Pan and plug in the Power Cord.**
→ See step 4 under "BASIC COOKING STEPS" on pg. 10
- 2 Hold the  button for more than 3 seconds.**

- You cannot change the Sound Signal during Cooking (Steaming), Regular Keep Warm, Extended Keep Warm, or Timer Cooking.
- If you find it difficult to change / select the Sound Signal, please start over from Step 1.

Each time the TIMER button is held for more than 3 seconds, the Sound Signal will change.

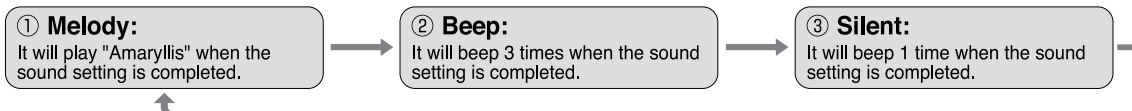

- 3 The setting is completed when the desired Sound Signal is heard.**

- The selected Sound Signal is stored even if the Rice Cooker is unplugged.

COOKING RICE

BASIC COOKING STEPS

- The initial Menu setting at the time of shipment from the factory is **WHITE / MIXED**.
- Please wash the Inner Cooking Pan, Inner Lid Set, Steam Vent Cap and accessories before initial use. → pg. 20–21

1 Measure the rice with the provided Measuring Cup.

Overfill the Measuring Cup with rice, then level off.

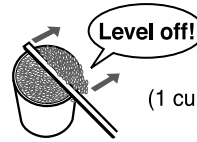

(1 cup = approx. 6.1 oz. / approx. 180 mL)

2 Clean the rice and adjust the amount of water.

- ① Clean the rice. → See "TIPS FOR COOKING DELICIOUS RICE" on pg. 8
- ② On a flat surface, pour water over the rice in the Inner Cooking Pan, filling to the water measure line that matches the number of cups of rice you are cooking and the Menu setting. → pg. 12
- ③ For an accurate measurement, level the surface of the rice.
 - The rice may be cooked immediately after cleaning rice, as soaking is not required. Soaking the rice will soften the texture of the rice.

3 Place the Inner Cooking Pan into the Main Body, and attach the Inner Lid Set and Steam Vent Cap. Close the Outer Lid.

Be sure to wipe moisture and foreign matter off the outer surface of the Inner Cooking Pan, the inside of the Main Body, the Inner Lid Set, and the Steam Vent Cap.

- Make sure that the Inner Cooking Pan is inserted all the way in.
- Close the Outer Lid slowly and firmly until you hear a clicking sound.

4 Insert plugs.

- ① Insert the Appliance Plug into the Main Body securely.
- ② Insert the Power Plug into an electrical outlet.

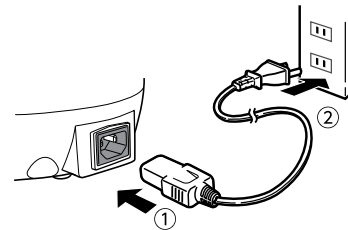

5 Select the desired Menu setting by pressing the **MENU** button.

Each press of the button changes the position of "▼" or "▶" on the Display.

- Press and hold the button to quickly cycle through the selections. It will stop when it reaches **WHITE / MIXED** menu setting.
- Menu settings such as **WHITE / MIXED**, **BROWN**, **GABA BROWN** and **JASMINE** will remain selected until you change the setting.

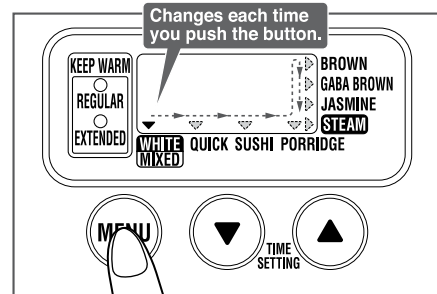

6 Press the **START** button.

The melody (beep) sounds, and cooking begins. The **START** light turns on, and, upon reaching the steaming process, the Display shows the estimated time (in minutes) until cooking completes.

- Do not put the Steaming Basket in the Rice Cooker while cooking rice if not also steaming other foods.

Ex. Display when cooking with the **WHITE / MIXED** menu setting.

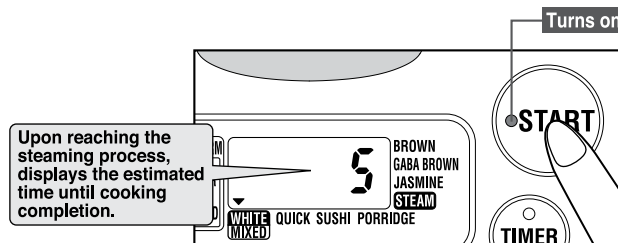

- The Rice Cooker will make adjustments to the remaining time until cooking completion when it reaches the steaming process. The time until cooking completion may increase or decrease suddenly during this process.

COOKING RICE **BASIC COOKING STEPS** (cont.)

7 When the melody or beep to indicate cooking completion sounds, stir and loosen the rice immediately to give the rice a deliciously fluffy texture.

When cooking completes, it will automatically switch to Keep Warm mode. → See "KEEPING RICE WARM" on pg. 14

The START light turns off, the REGULAR KEEP WARM light turns on, and the length of time that the rice has been kept warm is displayed in hour(s).

When it switches to Keep Warm mode, immediately stir and loosen the rice.

By stirring and loosening the rice and removing excess moisture, you prevent the rice from hardening, becoming sticky, or becoming burnt.

- Be careful not to burn yourself when stirring and loosening rice.

- The Inner Cooking Pan may spin when loosening the rice. Holding the Inner Cooking Pan with oven-mitts or a soft cloth will keep it from spinning while reducing damages to the outside bottom of the pan.
- Depending on cooking conditions, the bottom portion of the rice may become slightly browned.
- Depending on the heat convection while cooking, the surface of the finished rice may look uneven.

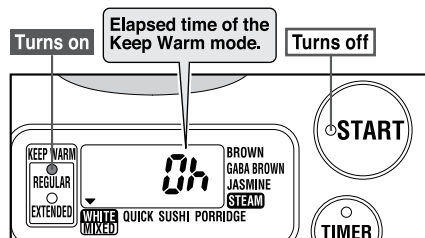

8 After use, press the **CANCEL** button, then unplug the Power Cord.

- Do not begin cleaning the Rice Cooker until the Main Body has cooled.
- Please do not handle the Power Plug or Appliance Plug while your hands are wet. (Doing so may cause short circuit or electric shock.)
- **Removing the Inner Cooking Pan only will not cancel the Keep Warm mode. Make sure to press the CANCEL button.**

Be careful that the contents do not boil over.

When adding water to the **PORRIDGE Water Level**, do not cook using menu settings other than **PORRIDGE**. Using any other menu setting may cause contents to boil over.

- The **PORRIDGE** menu setting selection will not be saved. When cooking porridge, please select it each time.

REQUEST

When cooking more than one pot of rice consecutively, or cooking right after cancelling the Keep Warm mode, allow the Rice Cooker to cool for 15 minutes or longer. If the Main Body and the Outer Lid are hot, the rice may not cook well.

REMARKS

- To cool the Main Body and Outer Lid quickly, please try the following:
- Fill the Inner Cooking Pan with cold water and place it in the Main Body.
 - Open the Outer Lid, remove the Inner Lid Set and allow the Radiator Plate to cool.

NOTE:

- You can switch Sound Signals (melody, beep, silent) that alert you when certain actions occur. → See "SOUND SIGNALS AND HOW TO CHANGE THEM" on pg. 9

ESTIMATED COOKING TIME

White Rice	approx. 50 minutes – 60 minutes
Mixed Rice	approx. 50 minutes – 60 minutes
Quick Cooking	approx. 29 minutes – 40 minutes
Sushi Rice	approx. 50 minutes – 60 minutes
Porridge	approx. 55 minutes – 70 minutes
Brown Rice	approx. 85 minutes – 110 minutes
GABA Brown Rice	approx. 220 minutes – 240 minutes
Jasmine Rice	approx. 50 minutes – 60 minutes

- The above table is based on the testing conditions of 120 volts, a room temperature of 68°F (20°C), and water at a starting temperature of 64.4°F (18°C).
- The above lengths of time are measured from Cooking until the Keep Warm process. Actual times may vary depending on the voltage, room temperature, season, and the amount of water used.

COOKING RICE

TIPS TO COOKING VARIOUS RICE MENUS

When cooking types of rice with assigned MENU settings:

Menus	Type of rice to use	Menu Setting	Water Level	Cooking Capacity [cups] *1	Merits/Advice
White Rice *2	Short/ Medium Grain White Rice	WHITE / MIXED	WHITE / MIXED	1–5.5	• Cooks white rice to a regular consistency.
Mixed Rice *2	Short/ Medium Grain White Rice	WHITE / MIXED	WHITE / MIXED	1–4	<ul style="list-style-type: none"> • Seasonings should be mixed with soup stock or water and then added to the rice. After adjusting the amount of water, stir thoroughly. If the seasonings are added directly to the rice or if not mixed properly, scorching or imperfect cooking may occur. • The recommended amount of ingredients should be about 30–50% of the rice volume. • Chop ingredients into small pieces and place evenly on top of the rice (do not mix into the rice).
Quick Cooking *2	Short/ Medium Grain White Rice	QUICK	WHITE / MIXED	1–5.5	• Choose this setting when you need to cook white rice in a hurry. Please note that the rice texture may be slightly harder.
Sushi Rice *2	Short/ Medium Grain White Rice	SUSHI	SUSHI	1–5.5	• Rice is firmer than when cooked using the White Rice setting.
Porridge *2	Short/ Medium Grain White Rice	PORRIDGE	PORRIDGE	0.5–1.5	<ul style="list-style-type: none"> • The recommended amount of ingredients should be about 30–50% of the rice volume. • Chop ingredients into small pieces and place on top of rice without mixing them into the rice. • Ingredients that do not cook easily should not be used in large amounts. • Boil green leaf vegetables separately and add them after the rice porridge has finished cooking. • Brown rice cannot be used to make porridge.
Brown Rice	Short/ Medium Grain Brown Rice	BROWN	BROWN	1–4	<ul style="list-style-type: none"> • Cooks brown rice. • If white rice is mixed with brown rice, it may boil over or imperfect cooking may occur, and is not recommended.
GABA Brown Rice	Short/ Medium Grain Brown Rice	GABA BROWN	BROWN	1–4	• Activates brown rice for increased nutritional values.
Jasmine Rice	Jasmine White Rice	JASMINE	JASMINE	1–5.5	• Depending on the rice brand, it may be slightly harder than normal. → pg. 22

*1 Capacity is measured in the supplied rice measuring cup, using raw rice.

*2 Only use short/medium grain white rice when cooking White Rice, Mixed Rice, Sushi Rice, or Porridge or when performing Quick Cooking.

USING THE TIMER TO COOK RICE

USING THE TIMER

- This function sets the Rice Cooker to automatically finish cooking by a specific time. Once set, the timer settings are stored in ⌚1 (Timer 1) or ⌚2 (Timer 2).
- The initial settings are 6:00 for "Timer 1", 18:00 for "Timer 2".
- Set the clock to the current time before setting the Timer function. If the clock is inaccurate, the cooking will not be completed at the time you set for the Timer. → pg. 9
- For pre-cooking preparations, see steps 1 through 4 under "BASIC COOKING STEPS" on pg. 10

1 Press the button to select the desired Menu setting.

- The Timer function is not available for QUICK and STEAM menu settings.
- Do not use the Timer function for the MIXED menu setting.

2 Press the button to select ⌚1 (Timer 1) or ⌚2 (Timer 2).

The preset time for "Timer 1" and the START light will blink.

- Press the button again and the preset time for "Timer 2" will appear.

3 Press the or button to set a specific time to finish cooking.

- ⏸ : Each press advances the time in 10-minute increments.
- ⏷ : Each press reverses the time in 10-minute increments.

- Press and hold the button to quickly adjust the time in 10-minute increments.
- You do not need to set the time again when using the same settings.

4 Press the button. The melody sounds and the Timer setting is complete.

The START light turns off, and the time you wish to finish cooking and the TIMER light turn on.

- The START button must be pressed to set the TIMER.
- Cooking will be completed at the specified time. → See step 7 under "BASIC COOKING STEPS" on pg. 11
- To cancel the Timer setting, press the CANCEL button.

Ex. When setting Timer 1 to "7:30".
(WHITE / MIXED menu setting)

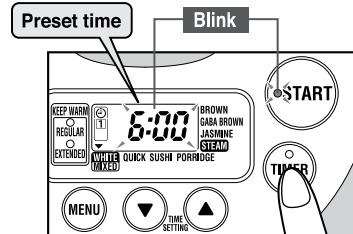

The time you wish to complete cooking.

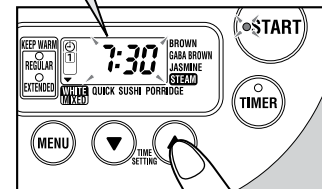

TIMER setting complete.

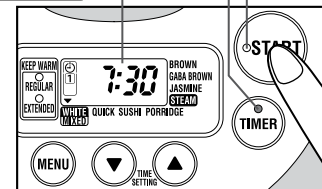

Suggested Lengths for the Timer Setting:



White Rice	1 hour – 13 hours
Sushi Rice	1 hour – 13 hours
Porridge	1 hour 10 minutes – 13 hours

Brown Rice	1 hour 50 minutes – 13 hours
GABA Brown Rice	4 hours 15 minutes – 13 hours
Jasmine Rice	1 hour 20 minutes – 13 hours

REQUEST

- Do not use the Timer function if you are adding ingredients and/or seasonings to the rice. Ingredients may spoil or seasonings may settle to the bottom of the Inner Cooking Pan and your results may not be satisfactory.
- Be sure to set the Timer for less than 13 hours, especially during summer, to prevent the soaked rice from spoiling due to the higher room temperature.

NOTE:

- The remaining time until cooking completion will not be displayed when the Timer is set.
- If the Timer is set for less than the suggested length above, a beep will sound and the Rice Cooker will start cooking immediately.
- Cooking may not complete at the set time if the temperature of the room or water is too low. In addition, the cooking time may be affected by the amount of water or voltage.
- When cooking using the Timer function, the rice absorbs extra moisture, which can make the rice softer or cause the bran to collect at the bottom and burn.
- If you want to know the current time while using the Timer function, press the  or  button and the Display will switch.

KEEPING RICE WARM

REGULAR KEEP WARM AND EXTENDED KEEP WARM

You can choose the Regular Keep Warm mode or Extended Keep Warm mode by pressing the KEEP WARM button while the KEEP WARM light is on.

● The Extended Keep Warm mode is not available during the following (the Rice Cooker will beep and automatically start the Regular Keep Warm mode):

- PORRIDGE, BROWN and GABA BROWN menu settings.
- If 12 hours of Regular Keep Warm has already elapsed.
- If 4 hours of Extended Keep Warm has already elapsed.
- If the temperature of the Inner Cooking Pan is low because the Keep Warm mode has been cancelled, or power failure.

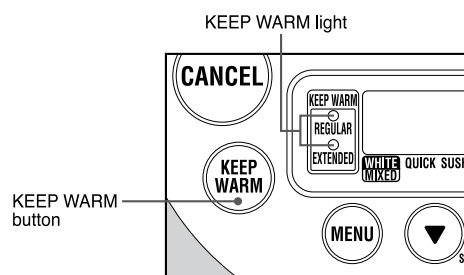

REGULAR KEEP WARM

This keeps the rice warm at a higher temperature, so the rice develops odors less easily.

When cooking completes, the Rice Cooker automatically switches to Regular Keep Warm mode and the REGULAR KEEP WARM light turns on.

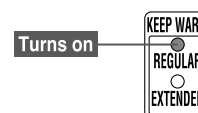

EXTENDED KEEP WARM

Use this function when keeping rice warm for a longer period of time. Drying and yellowing of rice will be reduced by maintaining the temperature slightly lower.

This function can be activated during Regular Keep Warm mode.

1 Check to make sure the REGULAR KEEP WARM light is on.

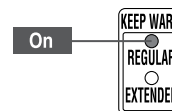

2 Press the  button.

The EXTENDED KEEP WARM light will turn on.

- After 8 hours of Extended Keep Warm mode, the Rice Cooker automatically switches to Regular Keep Warm mode.



How to change from Extended Keep Warm mode to Regular Keep Warm mode:

Press the  button.

The setting will return to Regular Keep Warm mode and the REGULAR KEEP WARM light will turn on.

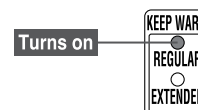

KEEPING RICE WARM (cont.)

HOW TO KEEP RICE WARM AGAIN

- When you want to keep rice warm after canceling the Keep Warm mode.

Press the  button.

The REGULAR KEEP WARM light turns on, and the time elapsed display returns to "0h".



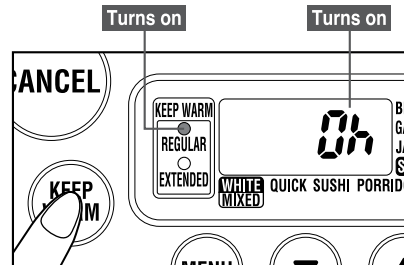

- If the temperature of the rice and the Inner Cooking Pan are low, do not keep warm again.



When you are concerned about the odor:

- Foul odors or the growth of bacteria may occur depending on how well the unit is cleaned, the room temperature based on the season or usage environment, frequent opening and closing of the Outer Lid, the type of rice used, or the way the rice was cleaned. If you are concerned about odors, cleaning the Rice Cooker according to "THE INTERIOR" on **pg. 21** and then using REGULAR KEEP WARM should be effective.

NOTE:

- If you want to know the current time during Keep Warm mode, press the  or  button and the Display will switch. Press the  or  button again to return to the display for Keep Warm time elapsed.

If you do not return the display to the Keep Warm time elapsed, the next time you cook rice, the Keep Warm time elapsed will not be displayed.

REQUEST

- When keeping rice warm inside the Inner Cooking Pan, be sure to select the Keep Warm mode.

HOW TO USE THE STEAM FUNCTION

1 Add water to the Inner Cooking Pan.

18 oz. / 540 mL (or 3 cups in the supplied Measuring Cup)

2 Place the Inner Cooking Pan into the Main Body and place the Steaming Basket.

Be sure to wipe moisture and foreign matter off the outer surface of the Inner Cooking Pan, the inside of the Main Body, the Inner Lid Set, and the Steam Vent Cap.



- Please make sure to place the Steaming Basket straight, or steam may escape from the gap.

3 Place food in the Steaming Basket, and attach the Inner Lid Set and Steam Vent Cap. Close the Outer Lid, and plug in the Power Cord.

- 1) Insert the Appliance Plug into the Main Body securely.
- 2) Insert the Power Plug into an electrical outlet.

- Place foods in the Steaming Basket evenly. The Steaming Basket may slant if the food is heavy on one side.

4 Select the STEAM menu setting by pressing the button.



- When the STEAM menu setting is selected, the default cooking time will appear in the Display. The cooking time may be lengthened or shortened using the Time Setting  or  buttons. See pg. 17 "Estimated Cooking Time."

Default Cooking Time	Possible Cooking Time
40 minutes	1–60 minutes

The cooking time includes the time it takes to boil the water.

5 Press the button.

The START light turns on and the melody/beep to start steaming will sound. The Display shows the remaining time until steaming completion.

- Press the Time Setting  or  button to check the current time during cooking.

Turns on

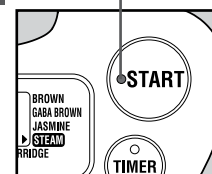

6 When the melody or beep to indicate cooking completion sounds, press the button and remove the food from the Steaming Basket.

- Remove the food from the Steaming Basket immediately after cooking completion, or the food may become wet or soggy.
- Be careful when opening the Outer Lid or removing the steamed dish or Steaming Basket, as the steam and the interior of the Main Body are very hot.
- Always press the CANCEL button when cooking completes. The Rice Cooker will beep every 30 minutes as a reminder to remove the food if the CANCEL button is not pressed.
- If the food needs more steaming, restart the process from Step 4 to steam a little longer.
- If there is smell of food left inside the Inner Cooking Pan, see pg. 20 "CLEANING AND MAINTENANCE: IF THERE IS AN ODOR" to remove the smell.
- The Steaming Basket may become stained from deeply colored ingredients (especially carrots and leaf-type vegetables). To prevent stains, place a parchment paper inside the Steaming Basket and place ingredients on top.

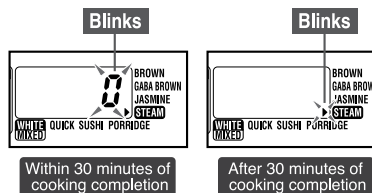

NOTE:

- Clean food scum from ingredients such as chicken or fish after cooking.
- Place steamed vegetables in ice water immediately after cooking and drain them off to preserve their bright color.

HOW TO USE THE STEAM FUNCTION (cont.)

Estimated Cooking Time:

Please make sure the height of the food does not exceed 1-½" / 3.5 cm, as it may hit the Inner Lid Set and cause breakdown or malfunction.

Ingredients	Amount	Estimated Cooking Time	Tips for Steaming
Carrot	1, approx. 7 oz. / 200 g	20 min.	Cut into bite-size pieces
Broccoli	½, approx. 7 oz. / 200 g	15 min.	Cut into bite-size pieces
Spinach	Approx. 3-½ oz. / 100 g	15 min.	Cut into bite-size pieces
Pumpkin	¼, approx. 9 oz. / 250 g	20 min.	Cut into bite-size pieces
Potato	3, approx. 16 oz. / 450 g	40 min.	Cut into bite-size pieces
Sweet potato	1, approx. 10-½ oz. / 300 g	35 min.	Cut into bite-size pieces
Corn	1, approx. 7 oz. / 200 g	30 min.	Cut into bite-size pieces
Chicken	1 fillet, approx. 10-½ oz. / 300 g	30 min.	Make cuts on the bottom side (that comes into contact with the Steaming Basket)
Fish (white fish, salmon, etc.)	Cut into fillets, approx. 5 oz. / 150 g	25 min.	Slice into less than 1 inch / 2 cm thickness and wrap in aluminum foil
Prawn	15, approx. 5 oz. / 150 g	20 min.	Steam without removing shells
Scallop	Approx. 5 oz. / 150 g	20 min.	Remove from shell (It is recommended to line the Steaming Basket with Chinese cabbage or cabbage to prevent the scallop from sticking)
Refrigerated meat dumpling, pot sticker (jiaozi), meat dumpling (xiaolongbao)	Approx. 7 oz. / 200 g	15 min.	Leave appropriate space between foods
Frozen meat dumpling, pot sticker (jiaozi), meat dumpling (xiaolongbao)	Approx. 7 oz. / 200 g	20 min.	Leave appropriate space between foods

NOTE:

Do not cook the following types of foods in the Rice Cooker:

- Thick foods such as curry and stews.
- Foods that may bubble over such as those using baking soda.
- Foods that expand after cooking such as processed seafood products and beans.
- Foods with large amounts of oil.
- Foods packaged in plastic bags.

When cooking...

- Do not use paper towels or other lids to cover the food.
- Remove any foreign objects on the outside of the Inner Cooking Pan, Heating Plate or Center Sensor. → **pg. 20-21**
- When using aluminum foil or parchment paper, do not completely cover the holes on the Steaming Basket, or allow it to extend outside the Steaming Basket. Doing so may cause breakdown, boiling over, or steam may leak.
- Steaming time will vary based on the room or water temperature, voltage or water measurement, size, amount and temperature of the food or other factors.
- If the food is undercooked, repeat the steam process to cook further by following steps **4** through **6**.
- When steaming consecutively, check to make sure there is enough water in the Inner Cooking Pan, and add water accordingly to prevent boil-dry.
- Steaming fish and meat for an extended time makes it tough. If it is not cooking through, slice them thinly before steaming. Adding herbs, garlic or flavoring with salt and pepper may reduce odor.

When cooking other foods together with rice...

- Cook the rice using the WHITE / MIXED menu setting.
- Do not cook more than 1 cup of rice (The Outer Lid may open during cooking, preventing the rice from cooking properly and the other ingredients from steaming properly.)
- Level the surface of the rice before cooking. → Failure to do so may cause the cooked rice to touch the Steaming Basket.
- Ingredients that require a comparatively long steaming time, such as potatoes, sweet potatoes, corn, pumpkin, and fish (wrapped in aluminum foil) can be cooked together. If they do not cook through properly, reduce the amount of ingredients or cut them into small pieces.
- Ingredients that require a comparatively short steaming time, such as spinach, will not steam properly.
- Do not add ingredients while the rice is cooking.
- The rice may burn more easily or take on the color of the other ingredients.

After cooking...

- Be careful when opening the Outer Lid or removing the steamed dish or Steaming Basket, as the steam and the interior of the Main Body are very hot and can cause burns.
- Oil and scum may soil the Inner Lid Set and the inside of the Outer Lid, especially when steaming meats. Always wash the Inner Lid Set, Inner Cooking Pan and Steaming Basket after each use, and wipe the Outer Lid Gasket and the Inside of the Outer Lid after each use to prevent odors or spoiling.
- Hot condensation may fall from the Inner Lid Set when the Outer Lid is opened and cause burns. Please exercise caution.

RECIPES

HAND-ROLLED SUSHI

Menu Setting: **SUSHI**

Ingredients (4–5 servings)

3 cups Rice

Mixed vinegar

4 Tbsp. Rice vinegar

1 Tbsp. Sugar

1-½ tsp. Salt

Suggested Toppings

Sashimi (tuna, squid, prawns, etc.)

Pickles (e.g. pickled radish)

Avocado and ham

Natto (fermented soy bean) and green onions

Bacon and asparagus

Salmon roe, sea eel and rolled egg

Carrots, cucumbers and celery

Seaweed, *Wasabi* (horse radish), soy sauce and pickled red ginger to taste



How to cook

- 1 Clean rice well and fill the Inner Cooking Pan with water to water level 3 for SUSHI.
- 2 Press the MENU button, select SUSHI and press the START button to start cooking.

- 3 When the Rice Cooker switches to the Keep Warm mode, place the rice into a wooden container (wiped with a clean wet cloth). Pour the mixed vinegar over the rice and mix thoroughly while cooling it with a fan.

- Hand-rolled sushi is simple and quick, wrapping your favorite sashimi, ingredients and sushi rice with *Nori* (seaweed). You can also use a green leaf to wrap your hand-rolled sushi.

MIXED RICE

Menu Setting: **WHITE/MIXED**

Ingredients (4–5 servings)

3 cups Rice

2 oz. (50 g) Chicken thigh

½ slice *Age* (fried tofu)

1 oz. (30 g) Carrots

1 oz. (30 g) *Konnyaku*

1 oz. (30 g) *Gobo*

2–3 Dried Shiitake mushrooms
(soaked in water to constitute)

A { 1-½ Tbsp. Light soy sauce

1-½ Tbsp. *Mirin* (sweet sake)

½ tsp. Salt

½ tsp. *Dashinomoto*

Soup taken from soaking dried Shiitake to taste

Stone parsley to taste



How to cook

- 1 Slice chicken thigh into ½ inch (1 cm) cubes. Place *Age* in a strainer and pour hot water over it; gently squeeze to drain excess oil, then slice into small strips. Soak chicken thigh and *Age* in soup stock **A** for 5 minutes (do not discard this soup stock).
- 2 Slice carrots and *Konnyaku* into small strips, soak *Konnyaku* in hot water and drain. Shred *Gobo*, soak in water until soft, then drain. Cut Shiitake into small strips.
- 3 Add the soup stock from Step 1 to the water used to soak the dried Shiitake, and mix them well.
- 4 Clean rice and add the mixture from Step 3. Fill the Inner Cooking Pan with water to water level 3 for WHITE / MIXED, and mix well from the bottom of the pan.

- 5 Place the ingredients from Steps 1 and 2 on top of the rice from Step 4 and spread evenly across the top. Do not mix the ingredients with the rice. Changing the amounts of rice and ingredients may cause imperfect cooking.
- 6 Press the MENU button, select WHITE / MIXED and press the START button to start cooking.
- 7 When the Rice Cooker switches to the Keep Warm mode, mix the rice to loosen it.
- 8 Serve rice in a bowl and sprinkle stone parsley on top.

The measurements used in these Recipes:

- 1 Tablespoon = 0.5 oz. (15 mL)
- 1 teaspoon = 0.2 oz. (5 mL)

- Measure the rice with the provided Measuring Cup. (1 Cup = approx. 6.1 oz./approx. 180 mL)

AVOCADO & TUNA BOWL

Menu Setting: **WHITE/MIXED**

Ingredients (4–5 servings)

- 3 cups Rice
- 1 lb. (450 g) Raw tuna (sashimi grade)
- 2 Avocado
- A)**
 - 4 Tbsp. Soy sauce
 - 1 tsp. *Wasabi*, grated
 - Grated *Wasabi* to taste
 - Soy sauce to taste

How to cook

- 1 Clean rice well and fill the Inner Cooking Pan with water to water level 3 for **WHITE / MIXED**.
- 2 Press the **MENU** button, select **WHITE / MIXED** and press the **START** button to start cooking.
- 3 Slice the avocado in $\frac{1}{4}$ inch thickness and the raw tuna in $\frac{1}{2}$ inch thickness, marinate in **A**.
- 4 When the Rice Cooker switches to the Keep Warm mode, place the rice in a bowl and top with the marinated tuna and avocado.
- 5 Serve with additional *Wasabi* and soy sauce to taste.



MIXED BROWN RICE

Menu Setting: **BROWN**

Ingredients (4–5 servings)

- 3 cups Brown rice
- 3 oz. (80 g) Chicken thigh
- 1 slice *Age* (fried tofu)
- 1 oz. (30 g) each Carrots, *Konnyaku* and *Gobo*
- A)**
 - 3 Tbsp. Light soy sauce
 - $\frac{1}{2}$ Tbsp. *Mirin* (sweet sake)

How to cook

- 1 Slice chicken thigh into $\frac{1}{2}$ inch (1 cm) cubes. Place *Age* in a strainer and pour hot water over it; gently squeeze to drain excess oil, then slice into small strips.
- 2 Slice carrots and *Konnyaku* into small strips, soak *Konnyaku* in hot water and drain. Shred *Gobo*, soak in water until soft, then drain.
- 3 Clean rice and put **A** in the Inner Cooking Pan, add water to water level 3 for **BROWN**, and **mix well from the bottom of the pan**.
- 4 Place ingredients from Steps 1 and 2 on top of rice from Step 3. Do not mix the ingredients with the rice. Changing the amounts of rice and ingredients may cause imperfect cooking.
- 5 Press the **MENU** button, select **BROWN** and press the **START** button to start cooking.
- 6 When the Rice Cooker switches to the Keep Warm mode, mix the rice to loosen it.

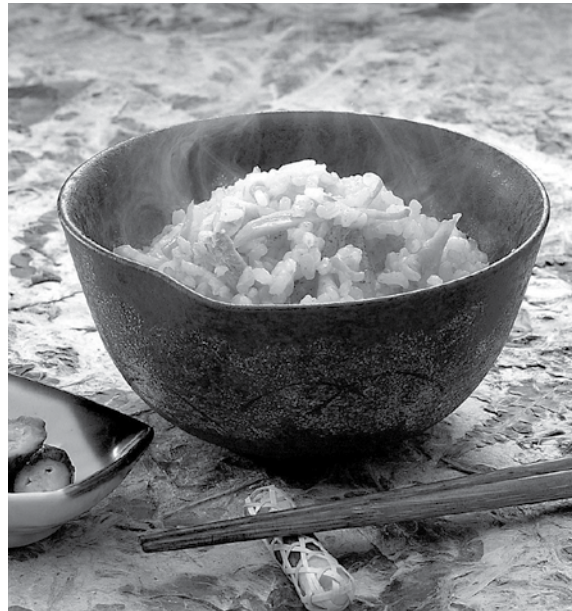

- Clean brown rice lightly to remove husks.
- When cooking rice with additional ingredients, limit the amount of rice to 1–4 cups.

CLEANING AND MAINTENANCE

● Clean the Rice Cooker thoroughly after every use.

- Be sure to unplug the Power Cord and allow the Main Body and the Inner Cooking Pan to cool down.
- Do not use such items as thinner, abrasive cleaners, bleach, scrubbing brushes (nylon, metal, etc.), melamine sponges or sponges with a nylon surface. (Doing so may damage the surface, causing discoloration, scratches, degradation in quality, or corrosion.)
- Do not use a dishwasher or dish-dryer. Doing so may cause scratches, deformation or discoloration.
- Be sure to reattach the Inner Lid Set and Steam Vent Cap correctly.

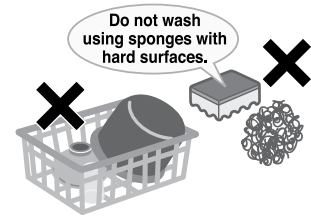

THE EXTERIOR

Wipe clean with a well-wrung soft cloth.

- If using a cloth that is chemically treated, use sparingly to avoid transferring the chemical smell and do not scrub the Rice Cooker forcefully. (Doing so may damage the surface, causing discoloration, scratches, degradation in quality, or corrosion.)

Open Button

If the Open Button becomes clogged with rice or other matter, remove with a bamboo stick.

- The Outer Lid may not open.

Air Vent

Clean using a vacuum cleaner (once a month).

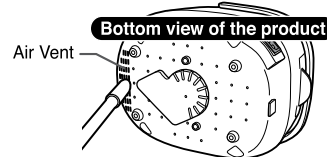

- Using the Rice Cooker with clogged Air Vent may cause the internal temperature to become abnormally high, resulting in breakdown.

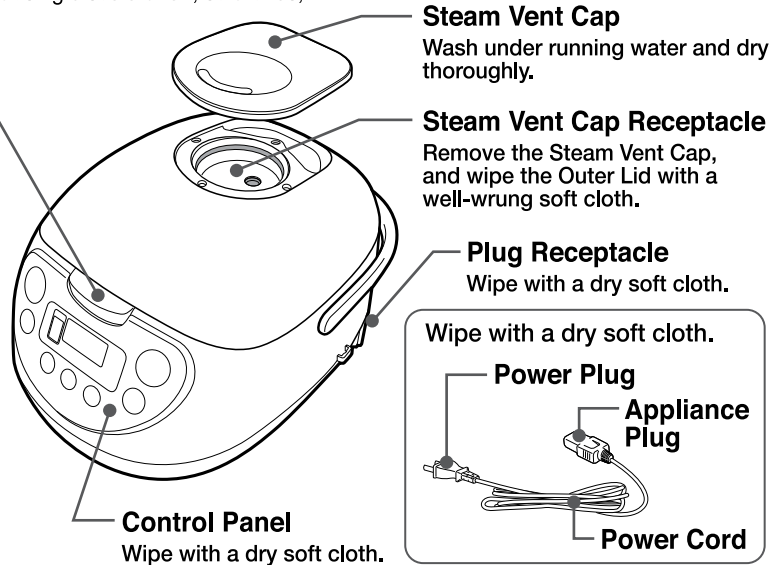

Steam Vent Cap

Wash under running water and dry thoroughly.

Steam Vent Cap Receptacle

Remove the Steam Vent Cap, and wipe the Outer Lid with a well-wrung soft cloth.

Plug Receptacle

Wipe with a dry soft cloth.

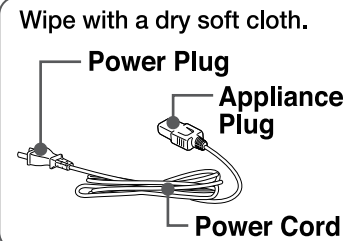

INNER COOKING PAN (→ pg. 5) / SPATULA / STEAMING BASKET

Wash using a neutral kitchen detergent and a soft sponge.

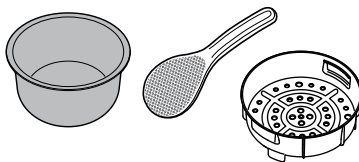

- Do not use polishing powder, metal or nylon scrubbing brushes.
- Handle gently. Do not strike it or rub it too hard.

MEASURING CUP / SPATULA HOLDER

Wash using a soft sponge.

To wash thoroughly, use a neutral kitchen detergent.



IF THERE IS AN ODOR

- 1** Fill the Inner Cooking Pan with water up to water level 1 for WHITE / MIXED.
 - Do not put anything else, such as kitchen detergent, in the Inner Cooking Pan.
- 2** Close the Outer Lid and press the **(MENU)** button to select the QUICK menu setting.
- 3** Press the **(START)** button.
- 4** When the melody (beep) sounds and switches to Keep Warm mode, press the **(CANCEL)** button.
- 5** Wait until the Main Body cools down, discard the water and clean accordingly.
 - Open the Outer Lid and dry the Rice Cooker in a well ventilated place.

CLEANING AND MAINTENANCE (cont.)

THE INTERIOR

Outer Lid Gasket

Wipe with a well-wrung soft cloth. Remove any rice or residue.

- The Outer Lid Gasket cannot be removed.

Inner Lid Set

Rinse in hot or cold water, wash using a soft sponge, and dry thoroughly.

- Remove rice or other matter. If not removed, steam may leak through, rice may dry, or cooking and Keep Warm may be imperfect.
- Do not remove the Inner Lid Knob.
- Be sure to clean the Inner Lid Set after every use; otherwise, it may rust or become discolored.

Center Sensor

Wipe with a well-wrung soft cloth. If it becomes clogged with rice or other matter, remove with a bamboo stick.

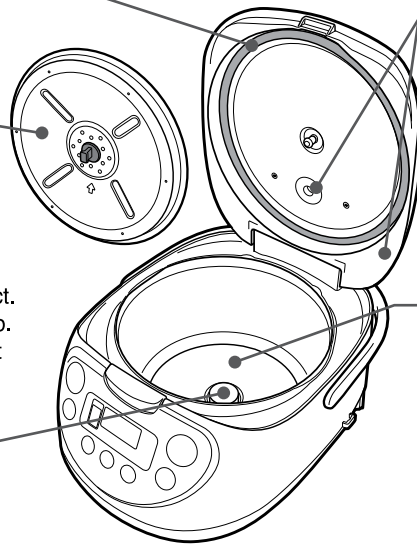

Outer Lid / Steam Vent

Hold the Outer Lid securely and wipe with a well-wrung soft cloth. Remove any rice or residue on the inside of the Outer Lid.

- Do not use kitchen detergents.
- Leaving rice, other matter or moisture on the surface may cause the Outer Lid to rust or discolor.

Heating Plate

Wipe the surface with a well-wrung soft cloth.

If rice or other matter become stuck to the Heating Plate, lightly polish them off with a sand paper of about No. 320 after dipping in water.

If it becomes clogged with rice or other matter, remove with a bamboo stick.

HOW TO DETACH AND ATTACH THE INNER LID SET

How to detach the Inner Lid Set:

Hold the Outer Lid with one hand and pull the Inner Lid Knob toward you with the other hand.

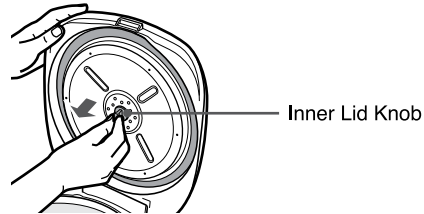

How to attach the Inner Lid Set:

Affix the hollow part of the Inner Lid Set (opposite side of the Inner Lid Knob) to the Inner Lid Set Mounting Axis to attach the Inner Lid Set.

Opposite side of the Inner Lid Knob.

Affix this hollow part to the Inner Lid Set Mounting Axis.

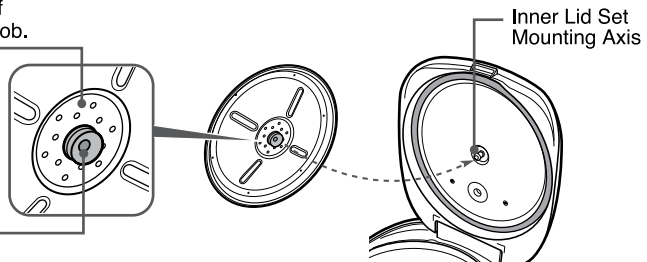

REPLACEMENT PARTS

- Please replace damaged parts for optimum performance.
- When replacing parts, please check the model number and the parts name beforehand, then contact the store where you purchased the Rice Cooker or Zojirushi Customer Service.

Zojirushi Customer Service

1-800-733-6270
www.zojirushi.com

Parts Names	Parts Number
Inner Lid Set	C194-6B
Inner Cooking Pan	B480-6B
Spatula	SHAKN-6B
Spatula Holder	616864-00
Measuring Cup	615784-00
Steaming Basket	BU195031L-00

TROUBLESHOOTING GUIDE

● Please check the following points before calling for service.

Problems	Cause (Points to check)
<p>Rice cooks too hard or too soft:</p>	<ul style="list-style-type: none"> ● Increase or reduce water by 1–2 mm from the Water Level Line according to your preference. ● If the Rice Cooker is positioned on an uneven or tilted surface, the texture of the cooked rice may be too hard or too soft as the amount of water becomes inconsistent. ● The texture of rice varies depending on the brand of the rice, where it was harvested, and how long it was stored (new crop or old crop). ● The texture of rice varies depending on the room and water temperatures. ● Using the Timer may result in softer rice. ● If you cook rice using the QUICK menu setting, the rice may turn out sticky or hard. → Try using the WHITE / MIXED menu setting. ● Make sure the Inner Cooking Pan has not deformed. ● Rice may not have been cleaned sufficiently, allowing too much bran to be left on the rice grain. ● Did you loosen the rice after cooking was completed? → Loosen the rice immediately after cooking is completed. ● Is there moisture or foreign matter on the outer surface of the Inner Cooking Pan, the inside of the Main Body, the Inner Lid Set, or the Steam Vent Cap? → Wipe them off. ● JASMINE may be slightly harder than normal. → To make it softer, fill the water slightly higher than the marked line on the Inner Cooking Pan (within 1/2 of scale) and cook. However, please note that adding too much water may cause it to boil over.
<p>Rice is scorched:</p>	<ul style="list-style-type: none"> ● Foreign matter such as rice may be stuck to the outside of the Inner Cooking Pan, the inside of the Main Body, on the Center Sensor or the Heating Plate. ● If you soak the rice for a long time or cook rice using the Timer, the bran may collect at the bottom, and the rice will be more easily scorched. ● Rice may not have been cleaned sufficiently, allowing too much bran to be left on the rice grain. ● Make sure the Inner Cooking Pan has not deformed.
<p>The surface of the cooked rice is uneven:</p>	<ul style="list-style-type: none"> ● Depending on the heat convection while cooking, the surface of the cooked rice may look uneven. ● Make sure the Inner Lid Set has not deformed. ● Make sure the Inner Cooking Pan has not deformed.
<p>Boils over while cooking:</p>	<ul style="list-style-type: none"> ● Did you use the wrong Menu setting or amount of water? → pg. 12 When cooking using the Porridge Menu, the contents are particularly likely to boil over, so be sure not to use the wrong amount of water. → See "Be careful that the contents do not boil over." on pg. 11 ● Make sure the Steam Vent Cap is attached. ● Rice may not have been cleaned sufficiently, allowing too much bran to be left on the rice grain. ● Make sure the Inner Cooking Pan has not deformed.
<p>Unable to start cooking or the buttons do not respond:</p>	<ul style="list-style-type: none"> ● Did you plug the Power Plug into the electrical outlet? ● Is the Appliance Plug disconnected from the Plug Receptacle? ● Does the Display show "E01" or "E02"? → pg. 25 ● Is the KEEP WARM light on? → Press the CANCEL button and press the START button.
<p>Steam comes out from the gap between the Outer Lid and the Main Body:</p>	<ul style="list-style-type: none"> ● Please check that the Inner Lid Set has not been dropped or deformed, and that the Outer Lid Gasket is not torn. ● Has the Outer Lid Gasket become soiled? → Clean the Outer Lid Gasket. ● Make sure the Inner Cooking Pan has not deformed.
<p>COOKING RICE / KEEP WARM</p> <p>A noise is heard during Cooking / Keep Warm:</p>	<ul style="list-style-type: none"> ● The microprocessor (MICOM) makes a sound while adjusting the heat power of the Rice Cooker. This does not indicate a problem. ● There is a spark-like noise when there is water left on the outside of the Inner Cooking Pan. → Always take precautions to wipe the outer surface of the Inner Cooking Pan and the inside of the Main Body clean, especially of moisture and foreign matters, before placing the Inner Cooking Pan into the Main Body.





TROUBLESHOOTING GUIDE (cont.)

Problems	Cause (Points to check)
<p>KEEP WARM</p> <p>During Keep Warm, rice has an odor, or rice becomes watery:</p> <p>During Keep Warm, rice becomes yellow or dry:</p> <p>The Display does not show the elapsed Keep Warm time:</p> <p>Extended Keep Warm is not accepted:</p>	<ul style="list-style-type: none"> ● Was the rice kept warm with the spatula left in the Inner Cooking Pan? ● Was cold rice reheated? ● Did you loosen the rice after cooking was completed? → Loosen the rice immediately after cooking is completed. ● Rice may not have been cleaned sufficiently and too much bran may be left. ● Some odor may remain after cooking mixed rice, etc. → Clean the Inner Cooking Pan thoroughly and perform "IF THERE IS AN ODOR" on pg. 20 ● The Keep Warm mode may not have been used for keeping rice warm. → Leaving rice in the Inner Cooking Pan without using the Keep Warm mode may cause unwanted odor. → pg. 8 ● Did you clean the Rice Cooker thoroughly after every use? → Foul odors or the growth of bacteria may occur depending on how well the unit is cleaned, the room temperature based on the season or usage environment, frequent opening and closing of the Outer Lid, the type of rice used, or the way the rice was cleaned. If you are concerned about odors, cleaning the Rice Cooker according to "THE INTERIOR" on pg. 21 and then using REGULAR KEEP WARM on pg. 14 should be effective.
	<ul style="list-style-type: none"> ● Are you keeping warm a small amount of rice in the Inner Cooking Pan? ● Was the Keep Warm mode used for more than 12 hours? ● The type of rice and water used may make the rice appear yellow.
	<ul style="list-style-type: none"> ● Does the Display show the current time? → Press the buttons for Time Setting to change the display. → See pg. 15 "NOTE".
	<ul style="list-style-type: none"> ● Did you select a Menu setting for which the Extended Keep Warm mode is not available? → pg. 14 ● Was the Keep Warm mode used for more than 12 hours? → If the Keep Warm mode is used for more than 12 hours, the Extended Keep Warm mode will not be accepted. ● Is the rice in the Inner Cooking Pan cold? → If the temperature of the Inner Cooking Pan is low, the Extended Keep Warm mode will not be accepted.
<p>TIMER COOKING</p> <p>The Rice Cooker starts cooking immediately after the Timer is set:</p> <p>The rice is not ready at the set time:</p> <p>The Timer cannot be set:</p>	<ul style="list-style-type: none"> ● Is the current time set correctly? → The clock is displayed in 24 hours (military time). Please check and set it again. ● If the Timer is set at a shorter time than suggested, it will begin cooking immediately.
	<ul style="list-style-type: none"> ● Is the current time set correctly? → The clock is displayed in 24 hours (military time). Please check and set it again. ● Cooking may not complete at the set time if the temperature of the room or water is too low. In addition, the cooking time may be affected by the amount of water or voltage.
	<ul style="list-style-type: none"> ● Did you press the START button after setting the time? → The START button must be pressed to complete setting the Timer. ● Is "7:00" blinking on the Display? → Unless the current time is set, the Timer function will not be accepted. → pg. 9 ● Have you selected a Menu setting that doesn't work with the Timer function? → The Timer function is not available for the QUICK and STEAM menu settings.

TROUBLESHOOTING GUIDE (cont.)

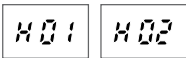
Problems		Cause (Points to check)
STEAM COOKING	Food does not steam:	<ul style="list-style-type: none"> ● Is there sufficient water for steaming? → pg. 16 ● Are there too many ingredients? → Reduce the amount of ingredients, or increase cooking time. ● Are the ingredients too large? → Cut ingredients into smaller sizes, or increase cooking time. → pg. 17 "Estimated Cooking Time"
	Steamed food is hard:	<ul style="list-style-type: none"> ● Vegetables: Steaming time is too short. Add more water and continue steaming. ● Fish and meat: Steaming time is too long. Reduce the steaming time.
	Steamed food is cold:	<ul style="list-style-type: none"> ● Has too much time elapsed since cooking was completed? → Do not leave on Keep Warm. Take out the ingredients immediately after cooking.
OTHER	The Outer Lid cannot be opened:	<ul style="list-style-type: none"> ● If you press the edge of the Open Button, the Outer Lid may be difficult to open. Be sure to press the center of the Open Button.
	The Outer Lid won't close:	<ul style="list-style-type: none"> ● Is the Inner Lid Set attached correctly?
	The Outer Lid opens during cooking:	<ul style="list-style-type: none"> ● Did you close the Outer Lid completely? → Be sure to close the Outer Lid until you hear a clicking sound.
	You mistakenly put the rice and water directly into the Main Body:	<ul style="list-style-type: none"> ● Putting rice and water directly into the Main Body may cause a malfunction. Contact the store where you purchased the Rice Cooker or Zojirushi Customer Service.
	There's a resinous odor, such as that of plastic:	<ul style="list-style-type: none"> ● When you use this Rice Cooker for the first time, there will be a resinous smell, such as that of plastic, but the odor will lessen as you use the Rice Cooker. If you are concerned about the odor, please see pg. 20 "IF THERE IS AN ODOR".
	When power failure occurs:	<ul style="list-style-type: none"> ● If too many appliances are used simultaneously, overload may occur and the breaker will cut off the electricity. → If another appliance is plugged in the same outlet as the Rice Cooker, unplug it before resetting the breaker. If the electric supply recovers within 10 minutes, the Rice Cooker will resume cooking automatically.
There is rust colored residue on the inside of the Outer Lid or the Inner Lid Set:		<ul style="list-style-type: none"> ● If rice residue is stuck on the Outer Lid or the Inner Lid Set and has discolored, clean it. → pg. 21

ERROR DISPLAYS AND THEIR MEANINGS

Panel Display	Cause (Points to check)
	<ul style="list-style-type: none"> ● Indicates malfunction. → Please contact the store where you purchased the Rice Cooker or Zojirushi Customer Service.
	<ul style="list-style-type: none"> ● The temperature of the Lid Sensor or the Center Sensor is too high. → Press the CANCEL button and open the Outer Lid for more than 15 minutes and allow the interior to cool down. (Be careful not to burn yourself.) → To cool faster, see pg. 11 "REMARKS."
<p>Error Display</p>  Blank Display:  is blinking:	<ul style="list-style-type: none"> ● The built-in Lithium Battery is out. The Display will turn off and stored memories (current time, menu selection and Keep Warm settings) will be erased when unplugged. However, once plugged in and the clock set, the Rice Cooker will function normally. If rice is cooked while the display shows a blinking , the current time will not be shown during the cooking process. Please contact Zojirushi Customer Service to have the Lithium Battery replaced (with additional charge).
<p>Odd Display:</p>	<ul style="list-style-type: none"> ● Unplug the Power Cord and plug it in again. (If the Display shows a blinking , please reset the time.) → pg. 9

SPECIFICATIONS

Model No.		NS-WTC10	
Cooking Capacity of Each Menu Setting*1 (approx. L) [cups]	WHITE (short/medium grain white rice)	0.18–1.0	[1–5.5]
	MIXED (short/medium grain white rice)	0.18–0.72	[1–4]
	QUICK (short/medium grain white rice)	0.18–1.0	[1–5.5]
	SUSHI (short/medium grain white rice)	0.18–1.0	[1–5.5]
	PORRIDGE (short/medium grain white rice)	0.09–0.27	[0.5–1.5]
	BROWN (short/medium grain brown rice)	0.18–0.72	[1–4]
	GABA BROWN (short/medium grain brown rice)	0.18–0.72	[1–4]
	JASMINE (jasmine white rice)	0.18–1.0	[1–5.5]
Height Limit for Steamed Foods		1-½ inch / 3.5 cm	
Rating		AC 120 V 60 Hz	
Electric Consumption		610 W	
Average Power Consumption during Keep Warm		29.5 W	
Rice Cooking System		Direct Heating	
Power Cord Length		3' 7" (1.1 m)	
External Dimensions	<approx. inch>	10 (W) x 13-1/8 (D) x 8-5/8 (H) (16-1/8 *2)	
	<approx. cm>	25 (W) x 33.5 (D) x 21.5 (H) (41 *2)	
Weight		approx. 7 lbs. (approx. 2.9 kg)	

- The average power consumption during Keep Warm is calculated with the Rice Cooker at maximum capacity and at a room temperature of 68°F (20°C).
 - This product may not operate properly in certain environments or places with high altitudes or extreme weather conditions. Please avoid using this product in such areas.
 - This product cannot be used in areas where power supply voltage or power supply frequency is different.
- *1 Capacity is measured in the supplied rice measuring cup, using raw rice. Other grains may vary.
 *2 Height with the Outer Lid open.

A large rectangular writing area with a thick gray border and horizontal dashed lines for writing. The writing area is white and contains 20 horizontal dashed lines, providing a guide for letter height and placement. The lines are evenly spaced and extend across the width of the writing area.



www.zojirushi.com

FOR CALIFORNIA USA ONLY

This product contains a CR Coin Lithium Battery which contains Perchlorate Material - special handling may apply. See www.dtsc.ca.gov/hazardouswaste/perchlorate

NS-WTC(1) ©(B)(A)