



USA

CAN

MICOM RICE COOKER & WARMER OPERATING INSTRUCTIONS

NS-TSC10A / NS-TSC18A

● Thank you for purchasing this product. Always follow basic safety precautions when using electrical appliances. Read all instructions carefully. Please keep these operating instructions at hand for easy reference.

INDEX

IMPORTANT SAFEGUARDS.....	2
PART NAMES AND FUNCTIONS.....	5
ABOUT THE INNER COOKING PAN.....	6
TIPS FOR DELICIOUS RICE.....	7
HOW TO SET THE CLOCK.....	8
HOW TO CHANGE THE NOTIFICATION SOUND.....	8
COOKING RICE	
BASIC COOKING STEPS.....	9
TIPS FOR COOKING VARIOUS RICE MENUS.....	11
ESTIMATED COOKING TIME.....	12
KEEPING RICE WARM	
REGULAR KEEP WARM AND EXTENDED KEEP WARM.....	13
REHEATING RICE.....	15
USING THE TIMER TO COOK RICE	
USING THE TIMER.....	16
HOW TO USE THE STEAM FUNCTION.....	17
RECIPES	
HAND-ROLLED SUSHI.....	19
CHIRASHI-SUSHI.....	19
MIXED RICE.....	20
CREAMY PARMESAN CHICKEN WITH MUSHROOM RICE.....	20
MIXED BROWN RICE.....	21
BROWN RICE WITH SALMON AND SHIITAKE.....	21
BLACK BEANS AND SWEET CORN QUINOA.....	22
CARROT CAKE STEEL CUT OATMEAL.....	22
CLEANING AND MAINTENANCE.....	23
TROUBLESHOOTING GUIDE.....	25
IF THE FOLLOWING OCCURS.....	28
ERROR DISPLAYS AND THEIR MEANINGS.....	28
REPLACEMENT PARTS.....	29
SPECIFICATIONS.....	29

IMPORTANT SAFEGUARDS

BASIC SAFETY PRECAUTIONS SHOULD ALWAYS BE FOLLOWED WHEN USING ELECTRICAL APPLIANCES, INCLUDING THE FOLLOWING.

- 1** Read all instructions thoroughly.
- 2** Avoid touching hot surfaces and do not close or clog the steam vent opening under any circumstances. The handles and knobs are provided for your safety and protection.
- 3** To prevent hazardous operation or electric shock, do not immerse power cord, power plug, or rice cooker (except inner cooking pan) in water or other liquids.
- 4** Close supervision is necessary when the appliance is used by or near children.
- 5** Unplug from outlet when not in use and before cleaning. Allow the appliance to cool before adding or removing parts, and before cleaning the appliance. Make sure appliance is OFF when not in use, before putting on or taking off parts, and before cleaning.
- 6** Do not use or operate the appliance with a damaged cord or plug. If the appliance malfunctions or has been damaged in any manner, unplug the appliance and return it to the nearest authorized service facility or dealer for examination, repair or adjustment.
- 7** The use of accessories or attachments not recommended by the appliance manufacturer may be hazardous or may cause malfunction.
- 8** Do not use outdoors.
- 9** Keep the power cord away from hot surfaces and do not let the cord hang over the edge of tables or counters.
- 10** Do not place the appliance on or near a heated surface such as a gas or electric stove, or in a heated oven.
- 11** Always use extreme caution when moving appliances containing hot contents or liquids.
- 12** Plug the cord into a household electrical outlet. To disconnect, turn the power control to OFF, then remove plug from wall outlet.
- 13** Do not use the appliance for other than intended or specified purposes.
- 14** To reduce the risk of electric shock, use only the supplied inner cooking pan.
- 15** The plug to the appliance should be attached first before plugging the cord into a wall outlet.

SAVE THESE INSTRUCTIONS

THIS APPLIANCE IS FOR HOUSEHOLD USE ONLY.

This appliance is supplied with a short power cord to reduce the risk of becoming entangled in or tripping over it. Extension cords may be used if care is exercised in their use. If an extension cord is used, the marked electrical rating of the cord should be at least as great as the electrical rating of the appliance, and a longer cord should be arranged so that it will not drape over the countertop or tabletop where it can be pulled on by children or tripped over unintentionally.

This appliance has a polarized plug (one blade is wider than the other). To reduce the risk of electric shock, this plug was designed to fit into a polarized outlet in only one direction. If the plug does not fit fully into the outlet, do not attempt to force it or modify it in any way. Simply reverse the plug and insert. If it still does not fit, contact a qualified electrician.

IMPORTANT SAFEGUARDS

Be sure to follow these instructions.

These WARNINGS and CAUTIONS are intended to prevent property damage or personal injury to you and others.











■ The degree of danger or damage by the misuse of this product is indicated as follows

 WARNINGS Indicates risk of serious injury or death.	 CAUTIONS Indicates risk of injury, household or property damage if mishandled.
--	---

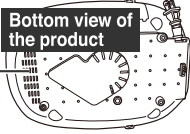
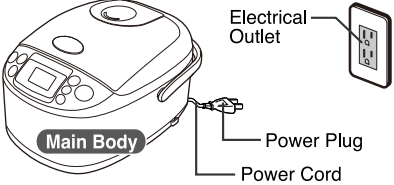
■ Prohibited or required actions are indicated as follows

 Indicates a prohibited operation.	 Indicates a requirement or instruction that must be followed.
---	---

! WARNINGS

<div style="margin-bottom: 10px;">  <p>Do not modify the Rice Cooker. Only a repair technician may disassemble or repair this unit. Attempting to do so may cause fire, electric shock or injury. Make any repair inquiries to Zojirushi Customer Service.</p> </div> <div style="margin-bottom: 10px;">  <p>Do not plug or unplug the Power Cord with wet hands. Doing so may cause electric shock or injury.</p> </div> <div style="margin-bottom: 10px;">  <p>Do not immerse the Rice Cooker in water or splash it with water. Do not pour water directly into the Rice Cooker. Doing so may cause short circuit or electric shock.</p> <p>Do not allow liquid to come in contact with the Power Plug or Power Cord. Doing so may cause short circuit or electric shock.</p> </div> <div style="margin-bottom: 10px;">  <p>Do not put any metal objects such as pins or wires into the Air Vent or crevices located at the bottom of the Rice Cooker. Doing so may cause electric shock or malfunction, resulting in injury.</p> <div style="display: flex; align-items: center; margin-top: 5px;"> <div style="margin-right: 10px;">Air Vent</div>  </div> <p>Do not allow children to use the Rice Cooker unsupervised. Keep it out of the reach of infants. Children are at risk of burns, electric shock or injury.</p> <p>Do not open the Outer Lid or move the Rice Cooker during cooking. Doing so may cause burns.</p> <p>This Rice Cooker is designed for cooking rice, keeping rice warm, and steaming only. Do not use it for anything other than its intended purposes. Always follow the Operating Instructions and never cook the following:</p> <ul style="list-style-type: none"> • Foods packaged in plastic bags. • Foods wrapped in parchment paper, aluminum foil, plastic wrap, etc. <p>Doing so may clog the steam exhaust route.</p> <p>Do not use the Rice Cooker if the Power Plug or Power Cord is damaged or if the Power Plug is loosely inserted into the electrical outlet. Doing so may cause electric shock, short circuit or fire.</p> <div style="margin-top: 10px;">  </div> </div> <td style="width: 50%; padding: 5px; vertical-align: top;"> <div style="margin-bottom: 10px;">  <p>Keep your hands and face away from the Steam Vent. Doing so may cause burns or scalding. Take special precautions with children and infants.</p> </div> <div style="margin-bottom: 10px;">  <p>Do not damage the Power Cord. Do not bend, pull, twist, bundle or attempt to modify the Power Cord. Do not place it on or near high temperature surfaces or appliances, under heavy items or between objects. A damaged Power Cord can cause fire or electric shock.</p> <p>Do not use a power source other than 120V AC. Use of any other power supply voltage may cause fire or electric shock.</p> <p>Do not allow the Power Plug to come into contact with steam. Allowing the Power Plug to come into contact with steam after inserting it into the electrical outlet may cause short circuit or fire. When using on a slide-out table or shelf, place the Rice Cooker in a position where the Power Plug does not come into contact with steam.</p> </div> <div style="margin-bottom: 10px;">  <p>Insert the Power Plug completely and securely into the electrical outlet. A loosely inserted Power Plug may cause electric shock, short circuit, smoke or fire.</p> <p>Use only an electrical outlet rated at 15 amperes minimum, and do not plug other devices into the same outlet. Plugging other devices into the same outlet may cause the electrical outlet to overheat, resulting in fire.</p> <p>If the blades or surface of the Power Plug become soiled, wipe them clean. A dirty Power Plug may cause fire.</p> <p>Stop using immediately if you notice any of the following symptoms indicating a malfunction or breakdown. Continued use of the Rice Cooker may cause smoke, fire, electric shock or injury.</p> <ul style="list-style-type: none"> • The Power Plug or Power Cord has become very hot. • The Power Cord is damaged or the electricity turns on and off when touched. • The body of the Rice Cooker is deformed or unusually hot. • Smoke is produced from the Rice Cooker or there is a burning smell. • Some part of the Rice Cooker is cracked, loose or unstable, etc. <p>If any of the above occurs, unplug the Rice Cooker immediately and contact the store where you purchased it or Zojirushi Customer Service for inspection and/or repair.</p> <p>This appliance is not intended for use by persons (including children) with reduced physical, sensory or mental capabilities, or lack of experience and knowledge, unless they have been given supervision or instruction concerning use of the appliance by a person responsible for their safety. Children should be supervised to ensure that they do not play with the appliance.</p> </div> </td>	<div style="margin-bottom: 10px;">  <p>Keep your hands and face away from the Steam Vent. Doing so may cause burns or scalding. Take special precautions with children and infants.</p> </div> <div style="margin-bottom: 10px;">  <p>Do not damage the Power Cord. Do not bend, pull, twist, bundle or attempt to modify the Power Cord. Do not place it on or near high temperature surfaces or appliances, under heavy items or between objects. A damaged Power Cord can cause fire or electric shock.</p> <p>Do not use a power source other than 120V AC. Use of any other power supply voltage may cause fire or electric shock.</p> <p>Do not allow the Power Plug to come into contact with steam. Allowing the Power Plug to come into contact with steam after inserting it into the electrical outlet may cause short circuit or fire. When using on a slide-out table or shelf, place the Rice Cooker in a position where the Power Plug does not come into contact with steam.</p> </div> <div style="margin-bottom: 10px;">  <p>Insert the Power Plug completely and securely into the electrical outlet. A loosely inserted Power Plug may cause electric shock, short circuit, smoke or fire.</p> <p>Use only an electrical outlet rated at 15 amperes minimum, and do not plug other devices into the same outlet. Plugging other devices into the same outlet may cause the electrical outlet to overheat, resulting in fire.</p> <p>If the blades or surface of the Power Plug become soiled, wipe them clean. A dirty Power Plug may cause fire.</p> <p>Stop using immediately if you notice any of the following symptoms indicating a malfunction or breakdown. Continued use of the Rice Cooker may cause smoke, fire, electric shock or injury.</p> <ul style="list-style-type: none"> • The Power Plug or Power Cord has become very hot. • The Power Cord is damaged or the electricity turns on and off when touched. • The body of the Rice Cooker is deformed or unusually hot. • Smoke is produced from the Rice Cooker or there is a burning smell. • Some part of the Rice Cooker is cracked, loose or unstable, etc. <p>If any of the above occurs, unplug the Rice Cooker immediately and contact the store where you purchased it or Zojirushi Customer Service for inspection and/or repair.</p> <p>This appliance is not intended for use by persons (including children) with reduced physical, sensory or mental capabilities, or lack of experience and knowledge, unless they have been given supervision or instruction concerning use of the appliance by a person responsible for their safety. Children should be supervised to ensure that they do not play with the appliance.</p> </div>
--	---

● The illustrations used in this Operating Instructions may vary from the actual product you have purchased.

Continued on the next page

IMPORTANT SAFEGUARDS (cont.)

⚠ CAUTIONS



Do not touch hot surfaces during or immediately after use.

Be careful of steam when opening the Outer Lid. Be careful not to touch the Inner Cooking Pan when loosening rice.

Touching hot surfaces may cause burns.

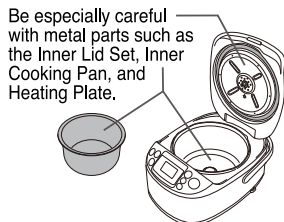

Do not place or use the Rice Cooker on unstable surfaces or on surfaces that are vulnerable to heat.

Doing so may cause fire.

Do not use the Rice Cooker on a slide-out table or shelf with insufficient load capacity.

Doing so may damage the slide-out table or shelf, causing the Rice Cooker to fall, resulting in injury or burns. The slide-out table or shelf should have a load capacity of 33 lbs./15 kg or more for the 1.0 L model, and 44 lbs./20 kg or more for the 1.8 L model.



Do not touch the Open Button when moving the Rice Cooker.

Doing so may cause the Outer Lid to open, resulting in injury or burns.

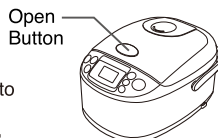

Do not use the Rice Cooker where it may come into contact with water or near heat sources.

Doing so may cause electric shock, short circuit, or can damage the Rice Cooker.

Do not use cookware other than the provided Inner Cooking Pan or Steaming Basket.

Doing so may cause the cookware or Steaming Basket to overheat or the Rice Cooker to malfunction.

Do not use the Rice Cooker near walls or furniture. Allow enough room for steam to escape if using beneath shelving.

Failing to allow enough room may cause breakdown. Steam or heat may also damage, discolor or deform walls, furniture or shelving.



Please allow the Rice Cooker to cool down before cleaning.

Hot parts such as the Inner Lid, Inner Cooking Pan and heating element may cause burns.

Always unplug the Rice Cooker by holding the Power Plug, not by pulling the Power Cord.

Pulling the Power Cord to unplug the Rice Cooker may cause electric shock, short circuit or fire.

Always retract the Power Cord holding the Power Plug.

Being struck by the Power Plug may result in injury.



Unplug the Power Plug from the outlet when the Rice Cooker is not in use.

Leaving the Power Plug connected to an outlet may cause the insulation to become damaged, resulting in burns, injury, electric shock, short circuit or fire.

If the Power Plug or Power Cord is damaged, it must be replaced by the manufacturer, its service agent, or similarly qualified persons to avoid hazards.

IMPORTANT

When you are finished, be sure to press the CANCEL button.

Removing the Inner Cooking Pan only will not cancel the Keep Warm mode.

Do not cover the Main Body, especially the Steam Vent, with a cloth or other object.

Doing so may cause breakdown.

Do not damage, drop or deform the Inner Cooking Pan.

A damaged Inner Cooking Pan may not cook properly.

Do not operate the Rice Cooker if rice or other foreign matter is stuck on the inside of the Main Body, the outside of the Inner Cooking Pan, the Center Sensor, or the Heating Plate.

Doing so may burn or otherwise discolor the rice.

Do not cook when the Inner Cooking Pan is empty.

Doing so may cause breakdown of the Rice Cooker or melting of the Steaming Basket.

Do not splash the Rice Cooker with water or place it on top of something wet.

Doing so may cause electric shock or breakdown.

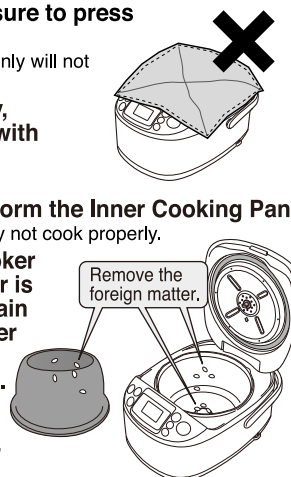

Do not use the Rice Cooker in direct sunlight.

Doing so may cause discoloration of the Rice Cooker.

Do not use the Rice Cooker where its steam may come into contact with other electrical appliances.

The steam may cause fire, malfunction, discoloration or deformation of other electrical appliances.

Always hold the Rice Cooker by the Handle when carrying it. Do not tilt the Main Body.

Doing so may cause the contents to spill.

Clean the Rice Cooker and the surrounding area before using it.

This Rice Cooker is equipped with an Air Vent to improve function and performance, but if dust or insects enter the Air Vent, the Rice Cooker may malfunction. If the Rice Cooker malfunctions due to insects, etc. entering the Air Vent, there will be a charge for repairs.

Do not use the Rice Cooker on top of an induction heating cooker. Doing so may cause breakdown.

This appliance is intended for household use and similar applications listed below.

- Staff (employee) kitchen area in shops, offices and other working environments.

*This appliance is not intended for use by many unspecified people for a long period of time.

This appliance must not be used in the following areas.

- Farmhouses.
- By clients in hotels, motels and other residential type environments.
- Bed and breakfast type environments.

PART NAMES AND FUNCTIONS

Steam Vent Cap

- Be sure to firmly insert the Steam Vent Cap.
- The Steam Vent Cap will be very hot while cooking and immediately afterward. Be very careful.

Steam Vent

- Steam arising from the vent is very hot while rice is cooking. Please exercise care.

Steam Vent Cap Receptacle

Open Button

Press the Open Button to open the Outer Lid.

About the Lithium Battery

A lithium battery is installed internally so that even if the Power Cord is unplugged, information such as the current time and Menu settings are saved. The lithium battery will wear out with use. → pg. 28

Air Vent
(bottom front of the Main Body)

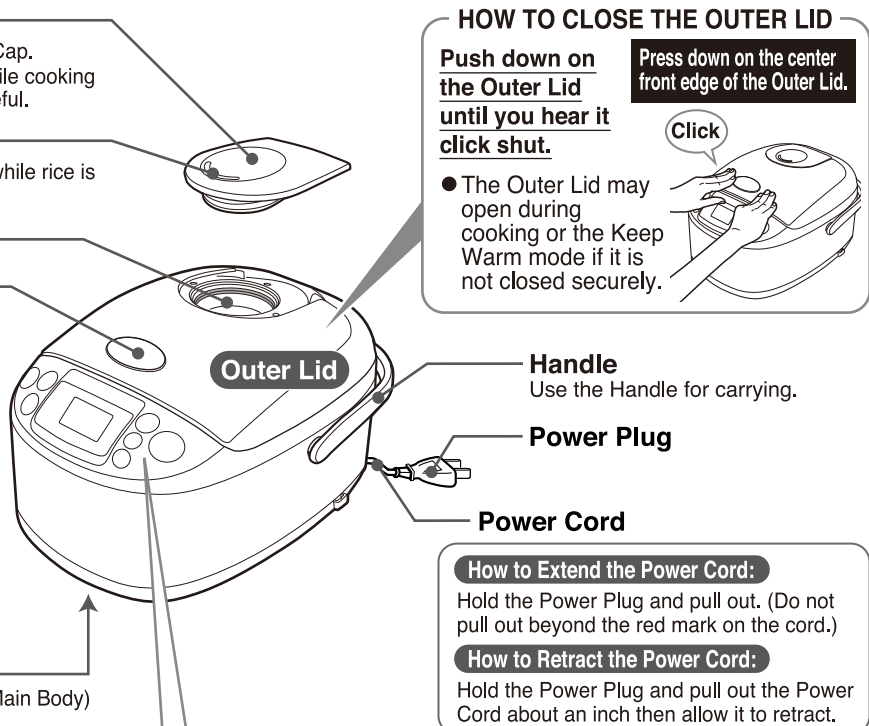

HOW TO CLOSE THE OUTER LID

Push down on the Outer Lid until you hear it click shut.

Press down on the center front edge of the Outer Lid.



- The Outer Lid may open during cooking or the Keep Warm mode if it is not closed securely.

Handle

Use the Handle for carrying.

Power Plug

Power Cord

How to Extend the Power Cord:

Hold the Power Plug and pull out. (Do not pull out beyond the red mark on the cord.)

How to Retract the Power Cord:

Hold the Power Plug and pull out the Power Cord about an inch then allow it to retract.

CONTROL PANEL

- Press buttons down firmly.
- The raised dot and dash (●, —) in the center of the START/REHEAT and CANCEL buttons and the Notification Sounds are provided for individuals with visual impairment.

Display

- Black lines that may appear on the LCD when wiped with a cloth are caused by static electricity and do not indicate a malfunction. Such lines disappear shortly.
- While the Power Plug is pulled out, the Display is off.

This Display is an example only, and will not appear in actual use.

MENU button

Use this button for setting the menu you will be using. → pg. 9

CANCEL button

Use this button to cancel the selected setting or function in operation.

KEEP WARM button

- During Keep Warm, use this button to select the Regular Keep Warm or Extended Keep Warm mode. → pg. 13
- Use this button to restart the Keep Warm mode. → pg. 14

KEEP WARM lights

TIME SETTING button

- Use this button when adjusting the current time. → pg. 8
- Use this button when setting the scheduled time for TIMER cooking. → pg. 16
- Use this button to set the time for steaming. → pg. 17

TIMER light

TIMER/MUTE button

- Use when cooking rice using the Timer function. → pg. 16
- Use this button when changing the Notification Sound. → pg. 8

START/REHEAT button

Use this button to initiate cooking, steaming, or reheating.

START/REHEAT light

ACCESSORIES

Spatula

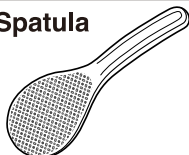

Spatula Holder



Steaming Basket



Measuring Cup



(1 Cup = approx. 6.1 oz./approx. 180 mL)

Continued on the next page

PART NAMES AND FUNCTIONS (cont.)

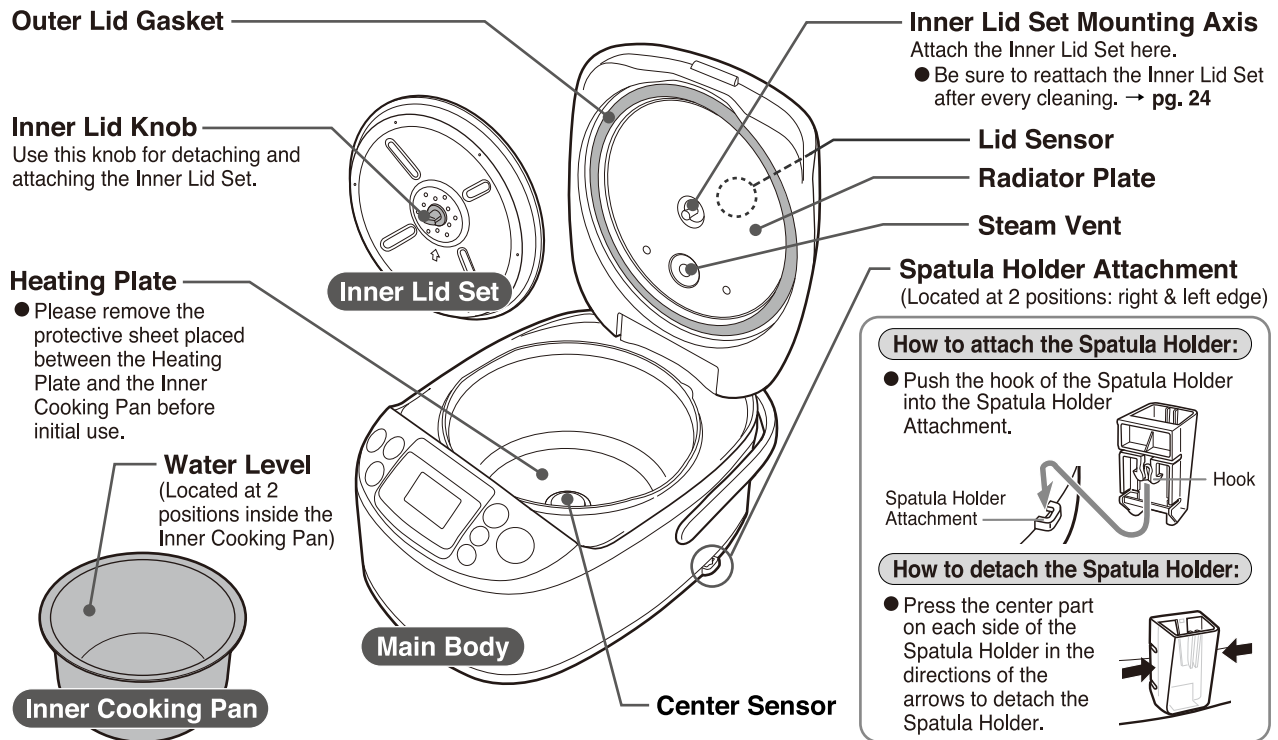

ABOUT THE INNER COOKING PAN

In order to use the Inner Cooking Pan for many years to come, please observe the following.

Inner Surface (Nonstick Coating)

The Nonstick Coating can peel off if damaged.

Please take special care to prevent damage and follow these precautions.

<During Preparation>

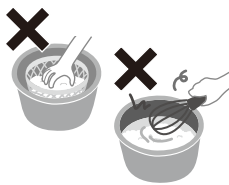

- Remove foreign matter (such as stones) from the rice before cleaning.
- Do not use utensils such as whisks to clean rice.
- Do not place a metal strainer in the Inner Cooking Pan when cleaning rice.
- Use the Inner Cooking Pan only for this Rice Cooker.

<When Cooking Completes>



- Do not pour vinegar into the Inner Cooking Pan (when making sushi rice).
- Do not use a metal ladle (when serving steel cut oatmeal, quinoa, etc.).
- Do not hit with the Spatula or other utensils (when serving, etc.).

<When Cleaning> → pg. 23

- Do not place utensils or dishes inside the Inner Cooking Pan.
- Do not place in a dishwasher or dish dryer.
- Clean the Inner Cooking Pan immediately after using any seasonings.
- Only use soft cleaning implements such as a sponge when cleaning.



- Do not use such items as thinner, abrasive cleaners, bleach, scrubbing brushes (nylon, metal, etc.), melamine sponges or sponges with a nylon surface.



The Nonstick Coating may wear out with use.

- The Nonstick Coating may eventually discolor or peel off. This will not affect the cooking / Keep Warm performances or its sanitary properties, and is harmless to your health.
- If concerned with the peeling of the Nonstick Coating or if the Inner Cooking Pan deforms, please replace it by purchasing a new one. → pg. 29

Outer Surface

- Heat may cause some discoloration, but this does not affect the cooking results.
- The outer surface touches important sensitive sensors. Be careful not to allow it to get dirty or damaged.
- Note that firmly pushing the bottom surface of the Inner Cooking Pan against a sink, table, or similar items may damage or discolor such items.

TIPS FOR DELICIOUS RICE

TIPS FOR COOKING DELICIOUS RICE

● Measure rice accurately

Be sure to use the Measuring Cup provided, as other measuring cups may differ. Level the rice off at the top of the cup to maintain accuracy.

● Clean rice quickly

Prepare a bowl to pool water

- ① **Rinse rice** First, pour plenty of water into the Inner Cooking Pan from the bowl and stir the rice loosely by hand 2 or 3 times (for 10 seconds or less). Drain the water immediately afterwards. Repeat twice.
- ② **Wash rice** Wash by stirring the rice by hand 30 times, pour plenty of water from the bowl and stir the rice loosely again. Drain the water immediately afterwards. Repeat this washing process 2-4 times.
- ③ **Rinse rice** Lastly, pour plenty of water from the bowl and rinse the rice. Repeat twice.

(Complete steps ①-③ within 10 minutes.)



Warning!

Do not clean the rice or adjust the amount of water using hot water (95°F/35°C or above). Doing so will cause the rice to be cooked improperly.

● Adjust the amount of water accordingly

Be sure to adjust the amount of water on a flat surface. The Water Level Line is a guideline. Adjust the amount of water according to preference, rice type, and crop age.

Type of Rice	New crop	Old crop
Water Adjustment	Reduce water slightly from the normal level	Add a little water to the normal level

- If you add too much water, it may boil over through the Steam Vent.

● Do not use strongly alkalinized ionic water

Do not use alkalinized ionic water that is over pH 9. Rice cooked with strongly alkalinized ionic water may appear yellow or become too glutinous.

● Stir and loosen rice immediately after cooking has completed

Doing so releases excess moisture, resulting in rice that is perfectly cooked with a fluffy texture. Loosen the rice within 10 minutes after cooking completes. Not loosening the rice may cause it to clump, become too glutinous or burn.

When Cooking 6 Cups of White Rice

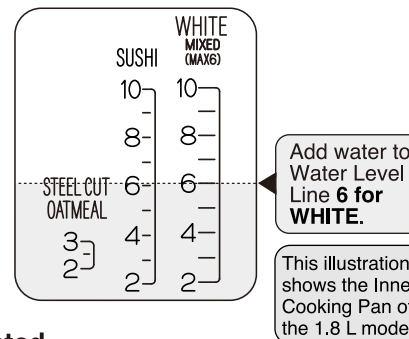

TIPS FOR USING THE KEEP WARM MODE

● When keeping rice in the Inner Cooking Pan for later consumption, use the Keep Warm mode.

- If rice is left in the Inner Cooking Pan with the Power Plug unplugged or with the Keep Warm mode canceled, the rice may develop a foul odor or condensed moisture may fall on the rice, making it soggy.

● To prevent the rice from becoming dry, wet, developing an odor or turning yellow, do not use the Keep Warm mode for the following.

- Keeping a small amount of rice warm for a long period.
- Keeping rice warm for more than 12 hours.
- Adding additional rice while keeping rice warm.
- Reheating cold rice.
- Keeping rice warm when it contains additional ingredients and seasonings (mixed rice, etc.).
- Keeping foods other than rice warm.
- Keeping rice warm with the Spatula left inside the Rice Cooker.
- Keeping steel cut oatmeal or quinoa warm.
- Keeping food cooked with the STEAM menu item warm.

● When keeping a small amount of rice warm, gather the rice toward the center of the Inner Cooking Pan.

- As the amount of rice kept warm decreases, the rice may dry or become wet. To minimize this, gather the rice toward the center of the Inner Cooking Pan while keeping warm.

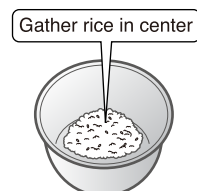

HOW TO SET THE CLOCK

If the clock is inaccurate, set the correct time as shown below.

- The clock is displayed in 24-hour (military) time.

e.g. If the current time is 15:01 but displays 14:56.

1 Set the Inner Cooking Pan and insert the Power Plug into an electrical outlet.

2 Press the ▲ or ▼ button.

3 Once the time display starts blinking, immediately adjust the clock to the current time.

▲ : Each press advances the time in 1-minute increments.

▼ : Each press reverses the time in 1-minute increments.

- Press and hold either button to quickly adjust in 10-minute increments.

4 The time display will stop blinking after 3 seconds, indicating the Time Setting is completed.

If the time display still does not show the current time, repeat Step 2 to readjust the time.

Adjusting time

Blinks

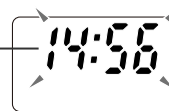

Press immediately once the time display starts blinking.



Time correction is completed

Stops blinking

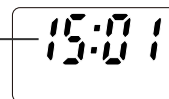

- Although the clock display turns off when the Power Plug is disconnected from the electrical outlet, the current time will reappear when the Power Plug is connected again.
- Although the clock is set before shipment from the factory, certain conditions such as room temperature may cause it to display an inaccurate time.
- If the clock is inaccurate, cooking will not be completed at the time you set for the Timer.
- The clock cannot be changed during Cooking (steaming), Reheating, Regular Keep Warm, Extended Keep Warm, or Timer Cooking.

HOW TO CHANGE THE NOTIFICATION SOUND

This product is equipped with a Notification Sound function, which will inform you when the Rice Cooker begins cooking (steaming), when the Timer is set, or when cooking (steaming) has completed. You can choose the sound type from Melody, Beep or Mute.

Types of Notification Sounds

Types of Notification Sounds and their meanings	Melody	Beep	Mute
Indication	Default setting at the time of shipment from the factory.	Choose this setting to change from a Melody.	Choose this setting to mute the Notification Sound.
Cooking (steaming) has begun	"Twinkle, Twinkle, Little Star"	a beep	no sound
Timer is set	"Twinkle, Twinkle, Little Star"	a beep	no sound
Cooking (steaming)/Reheating has completed	"Amaryllis"	beeps 5 times	no sound

How to Change the Notification Sound

1 Set the Inner Cooking Pan and insert the Power Plug into an electrical outlet.

2 Hold the  button for more than 3 seconds.

Each time the TIMER/MUTE button is held for more than 3 seconds, the Notification Sound will change.

- You cannot change the Melody Signal for the initiation of Reheating. (When the Notification Sound function is set to Mute, the Melody Signal does not sound upon the initiation of Reheating.)
- You cannot change the Notification Sound during Cooking (steaming), Reheating, Regular Keep Warm, Extended Keep Warm or Timer Cooking.
- If you find it difficult to change/select the Notification Sound, please start over from Step 1.
- Regardless of the setting, the buzzer indicating an error will sound.

① Melody

It will play "Amaryllis" when the sound setting is completed.

② Beep

It will beep 3 times when the sound setting is completed.

③ Mute

It will beep 1 time when the sound setting is completed.

3 The setting is completed when the desired Notification Sound is heard.

- The selected Notification Sound is stored even if the Power Plug is disconnected from the electrical outlet.

COOKING RICE BASIC COOKING STEPS

Wash the Inner Cooking Pan, Inner Lid Set, Steam Vent Cap, Spatula, Spatula Holder, Measuring Cup, and Steaming Basket before initial use. → pg. 23-24

1 Measure the rice with the provided Measuring Cup.

Overfill the Measuring Cup with rice, then level off.

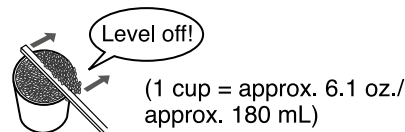

2 Clean the rice and adjust the amount of water.

- ① Clean the rice. → See “TIPS FOR COOKING DELICIOUS RICE” on pg. 7
- ② On a flat surface, pour water over the rice in the Inner Cooking Pan, filling to the Water Level Line that matches the number of cups of rice you are cooking and the Menu setting. → pg. 11
- ③ For an accurate measurement, level the surface of the rice.
 - The rice may be cooked immediately after cleaned, as soaking is not required. Soaking the rice will soften the texture of the rice.
 - The Water Level Line serves as a standard guideline and the amount of water should be adjusted according to preference. (Adjust 1-2 mm above or below the indicated Water Level Line.)

3 Place the Inner Cooking Pan into the Main Body, attach the Inner Lid Set and Steam Vent Cap, close the Outer Lid, and insert the Power Plug into an electrical outlet.

Be sure to wipe moisture and foreign matter off the outer surface of the Inner Cooking Pan, the inside of the Main Body, the Inner Lid Set, and the Steam Vent Cap.

- Make sure that the Inner Cooking Pan is inserted all the way in.
- Close the Outer Lid slowly and firmly until you hear a clicking sound.

4 Select the desired Menu setting by pressing the **MENU** button.

- The Menu setting at the time of shipment from the factory is **WHITE/SUSHI**.

Each time you press the button, the illuminated display item will switch between those shown with “◀”, and “▶” in the order of ①, ②.

- Press and hold the button to quickly cycle through the selections. It will stop when it reaches **WHITE/SUSHI** menu setting.
- Menu settings such as **WHITE/SUSHI**, **LONG GRAIN WHITE**, and **BROWN** menu settings will remain selected until you change the setting.

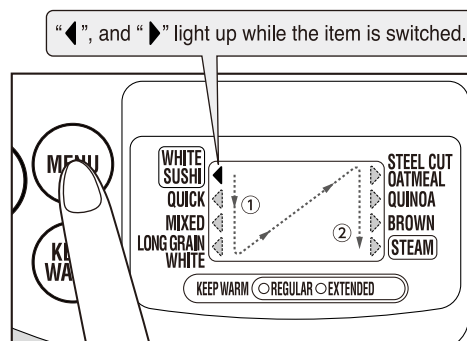

5 Press the **START/REHEAT** button.

The melody (beep) sounds, and cooking begins. The **START/REHEAT** light turns on, and the Display shows the estimated time (in minutes) until cooking completes.

- Make sure the Rice Cooker is not in the Keep Warm mode, then press the **START/REHEAT** button. If the Keep Warm light is on, the reheating process will start. → pg. 15
- If you want to know the current time during the cooking process, press the ▲ or ▼ button and the Display will switch only while the button is pressed.
- Do not put the Steaming Basket in the Rice Cooker while cooking rice if not also steaming other foods.

Ex. Display when cooking with the **WHITE/SUSHI** menu setting

Turns on

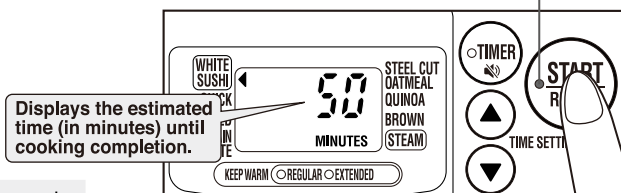

- The estimated time until cooking completion may differ from the actual time required. The actual time of cooking completion may vary depending on factors such as the room or water temperature, the voltage, or the water measurement.
- The Rice Cooker will make adjustments to the estimated time until cooking completion when it reaches the steaming process. The estimated time until cooking completion may increase or decrease suddenly during this process.

Continued on the next page

COOKING RICE (cont.)

6

When the melody (beep) that indicates cooking completion sounds, stir and loosen the rice immediately to give the rice a deliciously fluffy texture.

When cooking completes, it will automatically switch to the Keep Warm mode.

→ See “KEEPING RICE WARM” on pg. 13

The KEEP WARM light turns on and the START/REHEAT light turns off. The length of time that the rice has been kept warm is displayed in hours (HOURS).

When it switches to the Keep Warm mode, immediately stir and loosen the rice.

By stirring and loosening the rice and removing excess moisture, you prevent the rice from hardening, becoming soggy, or becoming burnt.

- Be careful not to burn yourself when stirring and loosening rice.

Do not close the Outer Lid with the Spatula inside the Rice Cooker. Doing so may make the Outer Lid difficult to open.

- The Inner Cooking Pan may spin when loosening the rice. Holding the Inner Cooking Pan (which is very hot immediately after use) with an oven-mitt or a soft cloth will keep it from spinning while reducing damage to the outside bottom of the pan.
- Depending on cooking conditions, the bottom portion of the rice may become slightly browned.
- Depending on the heat convection while cooking, the surface of the finished rice may look uneven.

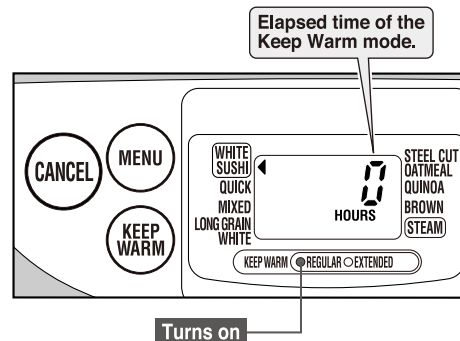

7

After use, remove all the rice from the Inner Cooking Pan, press the **CANCEL** button, unplug the Power Plug from the electrical outlet, and then clean the Rice Cooker.

- Do not begin cleaning the Rice Cooker until the Main Body has cooled. → pg. 23-24
- Please do not handle the Power Plug while your hands are wet. (Doing so may cause short circuit or electric shock.)
- Removing the Inner Cooking Pan only will not cancel the Keep Warm mode. Make sure to press the CANCEL button.

Be careful that the contents do not boil over.

When adjusting the amount of water to the STEEL CUT OATMEAL or QUINOA Water Level Line, do not cook using Menu settings other than STEEL CUT OATMEAL or QUINOA. Using any other Menu setting may cause the contents to boil over.

- The STEEL CUT OATMEAL and QUINOA menu setting selections will not be saved. When cooking steel cut oatmeal or quinoa, select the corresponding menu setting each time.

IMPORTANT

- When cooking more than one pot of rice consecutively, or cooking right after cancelling the Keep Warm mode, allow the Rice Cooker to cool for 45 minutes or longer. If the Main Body and the Outer Lid are hot, the rice may not cook well. Cooking rice without first allowing the Rice Cooker to cool may lead to a longer cooking time. (Up to approximately 60 minutes.) Also, the estimated time until cooking completion may not be displayed for some time in this situation.

TIPS

To cool the Main Body and Outer Lid quickly, please try the following:

- Fill the Inner Cooking Pan with cold water and place it in the Main Body.
- Open the Outer Lid, remove the Inner Lid Set and allow the Radiator Plate to cool.

NOTE

- You can switch the Notification Sounds (melody, beep, mute) that alert you when certain actions occur. → See “HOW TO CHANGE THE NOTIFICATION SOUND” on pg. 8

TIPS FOR COOKING VARIOUS RICE MENUS

*Capacity is measured in the supplied rice measuring cup, using uncooked rice.

Type of rice you want to cook	Type of rice to use	Menu Setting	Water Level	Cooking Capacity [cups]*	Notes and Advice
White Rice	Short/Medium Grain White Rice	WHITE/SUSHI	WHITE	1.0 L: 1-5.5 1.8 L: 2-10	
Sushi Rice	Short/Medium Grain White Rice	WHITE/SUSHI	SUSHI	1.0 L: 1-5.5 1.8 L: 2-10	
Quick Cooking	Short/Medium Grain White Rice	QUICK	WHITE	1.0 L: 1-5.5 1.8 L: 2-10	<ul style="list-style-type: none"> Cooks white rice faster. Please note that the rice texture may be slightly harder.
Mixed Rice	Short/Medium Grain White Rice	MIXED	WHITE	1.0 L: 1-4 1.8 L: 2-6	<ul style="list-style-type: none"> Seasonings should be mixed with soup stock or water and then added to the rice. After adjusting the amount of water, stir thoroughly. If the seasonings are added directly to the rice or if not mixed properly, scorching or imperfect cooking may occur. The recommended amount of ingredients should be 30-50% of the rice weight. Chop ingredients into small pieces and place on top of rice without mixing them into the rice.
Long Grain White Rice	Long Grain White Rice	LONG GRAIN WHITE	LONG GRAIN WHITE	1.0 L: 1-5.5 1.8 L: 2-10	<ul style="list-style-type: none"> Depending on the rice brand, it may be slightly harder than normal. → pg. 25
Steel Cut Oatmeal	Steel Cut Oatmeal	STEEL CUT OATMEAL	STEEL CUT OATMEAL	1.0 L: 1-2.5 1.8 L: 2-3	<ul style="list-style-type: none"> Adjust the amount of water according to your preference. For firmer oats → Use less water. For softer oats → Use more water.
Quinoa	Quinoa	QUINOA	QUINOA	1.0 L: 1-4 1.8 L: 2-6	<ul style="list-style-type: none"> Adjust the amount of water according to your preference. For firmer quinoa → Use less water. For softer quinoa → Use more water.
Brown Rice	Short/Medium Grain Brown Rice	BROWN	BROWN	1.0 L: 1-4 1.8 L: 2-8	<ul style="list-style-type: none"> Cooks brown rice. If white rice is mixed with brown rice, it may boil over or imperfect cooking may occur. Therefore, a mixture like this is not recommended.

Continued on the next page

TIPS FOR COOKING VARIOUS RICE MENUS (cont.)

ESTIMATED COOKING TIME

Menu	1.0 L model	1.8 L model
WHITE	Approx. 45 minutes – 60 minutes	Approx. 45 minutes – 60 minutes
SUSHI	Approx. 45 minutes – 60 minutes	Approx. 45 minutes – 60 minutes
QUICK	Approx. 29 minutes – 40 minutes	Approx. 30 minutes – 45 minutes
MIXED	Approx. 55 minutes – 65 minutes	Approx. 55 minutes – 65 minutes
LONG GRAIN WHITE	Approx. 53 minutes – 64 minutes	Approx. 53 minutes – 64 minutes
STEEL CUT OATMEAL	Approx. 54 minutes – 61 minutes	Approx. 57 minutes – 64 minutes
QUINOA	Approx. 38 minutes – 44 minutes	Approx. 38 minutes – 44 minutes
BROWN	Approx. 85 minutes – 110 minutes	Approx. 85 minutes – 110 minutes

- The above table is based on the testing conditions of 120 volts, a room temperature of 68°F (20°C), and water at a starting temperature of 64.4°F (18°C).
- The above lengths of time are measured from Cooking until the Keep Warm process. Actual times may vary depending on the voltage, room temperature, season, and the amount of water used.

KEEPING RICE WARM

REGULAR KEEP WARM AND EXTENDED KEEP WARM

You can choose the Regular Keep Warm mode or Extended Keep Warm mode by pressing the Keep Warm button while the KEEP WARM light is on.

- The Extended Keep Warm mode is not available in the following cases. The Rice Cooker will beep and automatically start the Regular Keep Warm mode.
 - MIXED, STEEL CUT OATMEAL, QUINOA, BROWN menu settings.
 - If 12 hours of Regular Keep Warm has already elapsed.
 - If 4 hours of Extended Keep Warm has already elapsed.
 - If the temperature of the Inner Cooking Pan is low because the Keep Warm mode has been cancelled, or power failure.

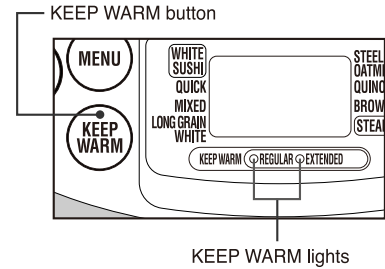

REGULAR KEEP WARM

This keeps the rice warm at a higher temperature, so the rice develops odors less easily.

When cooking completes, the Rice Cooker automatically switches to the Regular Keep Warm mode and the REGULAR KEEP WARM light turns on.

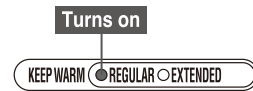

EXTENDED KEEP WARM

Use this function when keeping rice warm for a longer period of time. Drying and yellowing of rice will be reduced by maintaining the temperature slightly lower.

This function can be activated during the Regular Keep Warm mode.

1 Check to make sure the REGULAR KEEP WARM light is on.

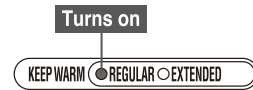

2 Press the  button. The EXTENDED KEEP WARM light will turn on.

- After 8 hours of the Extended Keep Warm mode, the Rice Cooker automatically switches to the Regular Keep Warm mode.

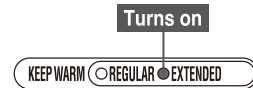

How to change from the Extended Keep Warm mode to the Regular Keep Warm mode

Press the  button. The setting will return to the Regular Keep Warm mode and the REGULAR KEEP WARM light will turn on.



ABOUT KEEP WARM TIMES

- Be sure to observe the length of time for which rice can be kept warm as shown in the table below.
- You cannot select EXTENDED KEEP WARM for the menus marked with a “—”. REGULAR KEEP WARM is automatically selected.
- After cooking, all menus default to the Keep Warm mode. However, do not use the Keep Warm mode for the menus with an “X” below. Doing so can cause spoilage and foul odors.

Menu	WHITE · SUSHI · QUICK · LONG GRAIN WHITE	MIXED · STEEL CUT OATMEAL · QUINOA	BROWN
KEEP WARM			
REGULAR KEEP WARM	Up to 12 hours	X	Up to 12 hours
EXTENDED KEEP WARM		—	—

- When 12 hours have elapsed, the number will begin to blink as a warning. Consume the rice as soon as possible.

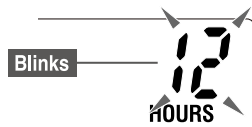

- For the menus with an “X” above, the number will begin blinking at 0 hours. Do not use the Keep Warm mode for these menus.

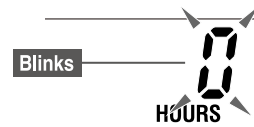

Continued on the next page

KEEPING RICE WARM (cont.)

HOW TO KEEP RICE WARM AGAIN

- When you want to keep rice warm after canceling the Keep Warm mode.

Press the  button.

The REGULAR KEEP WARM light turns on, and the time elapsed display returns to "0 HOURS".



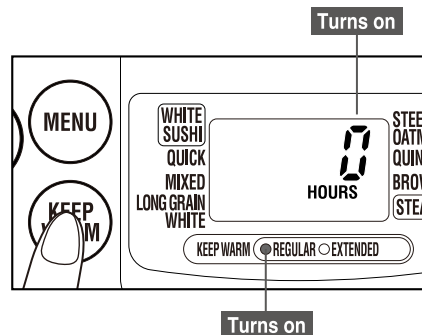

- If the temperatures of the rice and the Inner Cooking Pan are low, do not keep warm again. Trying to keep contents warm again when the rice and Inner Cooking Pan temperatures are low will cause "0 (HOURS)" to blink.



When you are concerned about the odor

- Foul odors or the growth of bacteria may occur depending on how well the unit is cleaned, the room temperature based on the season or the usage environment, frequent opening and closing of the Outer Lid, the type of rice used, or the way the rice was cleaned. If you are concerned about odors, cleaning the Rice Cooker according to "THE INTERIOR" on **pg. 24** and then using REGULAR KEEP WARM should be effective. It can be even more effective to increase the warming temperature, as described on **pg. 28**, "IF THE FOLLOWING OCCURS".

NOTE

- If you want to know the current time during the Keep Warm mode, press the  or  button and the Display will switch. Press the  or  button again to return to the display for the Keep Warm time elapsed.

If you do not return the display to the Keep Warm time elapsed, the next time you cook rice, the Keep Warm time elapsed will not be displayed. If the Keep Warm time elapsed display is blinking, you cannot switch.

- The Keep Warm mode cannot be used with the STEAM menu setting.

IMPORTANT

- When keeping rice in the Inner Cooking Pan for later consumption, you must use the Keep Warm mode.

REHEATING RICE

You can use this function during the Regular Keep Warm mode or Extended Keep Warm mode.

- This Reheat function is for reheating the rice during the Keep Warm mode to make the rice hotter. Particularly, when the rice is kept warm at a lower temperature by the Extended Keep Warm mode, the Reheat function will reheat the rice to the best serving temperature.
- You can reheat the rice only when the KEEP WARM light is on.

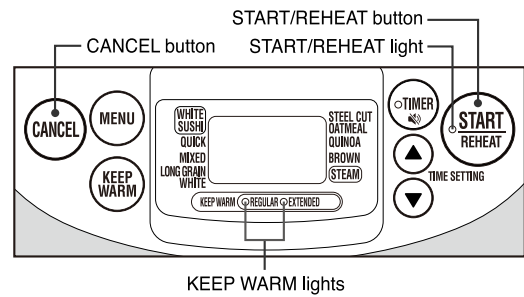

1 Loosen and level the surface of the rice that is being kept warm.

- Be sure to loosen the rice to prevent scorching or the rice from becoming hard.
- To reheat a small amount of rice, add 1 tablespoon of water for each bowl of rice (approx. 5.5 oz./approx. 160 g), mix well, and gather the rice toward the center of the Inner Cooking Pan. Doing so will minimize dryness.
- Be careful not to burn yourself when stirring and loosening the rice.
- The Inner Cooking Pan may spin when loosening the rice. Holding the Inner Cooking Pan (which is very hot immediately after reheating) with an oven-mitt or a soft cloth will keep it from spinning while reducing damage to the outside bottom of the pan.



2 Make sure that the KEEP WARM light is on, and press the button.

A melody sounds, and reheating starts. The KEEP WARM light turns off, the START/REHEAT light blinks, and the display looks like the illustration below.

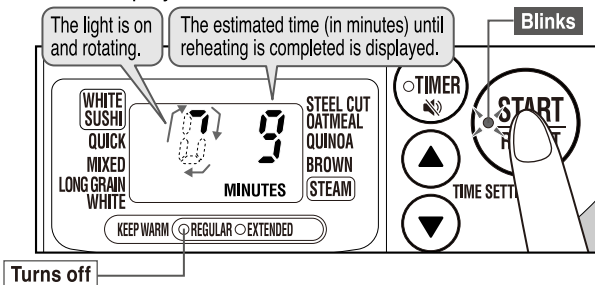

NOTE

Turns on



If you press the START/REHEAT button when the KEEP WARM light is off, the cooking process will start.

Standard times required for reheating

Approx. 7 min. – 9 min.

Approx. 7 min. – 9 min. later

The melody (beep) sounds, and reheating is finished.

The START/REHEAT light turns off, the KEEP WARM light turns on, and the Rice Cooker switches to the Regular Keep Warm mode.

3 Loosen the rice.

- Loosen and level the surface of the rice, as the rice at the bottom may be harder.
- Be careful not to burn yourself when stirring and loosening the rice.
- The Inner Cooking Pan may spin when loosening the rice. Holding the Inner Cooking Pan (which is very hot immediately after reheating) with an oven-mitt or a soft cloth will keep it from spinning while reducing damage to the outside bottom of the pan.

To cancel the Reheat mode and return to the Keep Warm mode

Press

the  button.

The START/REHEAT light turns off, the KEEP WARM light turns on, and the Rice Cooker switches to the Regular Keep Warm mode.

To cancel the Reheat mode and return to the Keep Warm mode

Press

the  button.

The START/REHEAT light turns off, and the current time display returns.

Do not reheat for the following cases

- Do not use the Reheat function to reheat food other than white rice, as reheating other types of rice may cause scorching or discoloring.
- Do not repeat the Reheat function as doing so may cause scorching or dryness.
- Do not use the Reheat function if the amount of rice left over is above Water Level Line 3 (for 1.0 L model) or 6 (for 1.8 L model) for WHITE as the rice may not be warmed adequately.
- Do not use the Reheat function if the rice is cold or the temperature of the Inner Cooking Pan is too low as doing so may cause scorching, foul odors or the rice may become hard.

USING THE TIMER TO COOK RICE

USING THE TIMER

- This function sets the Rice Cooker to automatically finish cooking by a specific time. Once set, the timer settings are stored in “Timer 1” or “Timer 2”.
- The initial settings are 6:00 for “Timer 1”, 18:00 for “Timer 2”.
- Set the clock to the current time before setting the Timer function. If the clock is inaccurate, the cooking will not be completed at the time you set for the Timer. → pg. 8
- If you set the Timer shorter than the Lengths for the Timer Setting, a beep will sound, the Rice Cooker will start cooking immediately, and the estimated time until cooking completion will be displayed.
- For pre-cooking preparations, see steps 1 through 3 under “BASIC COOKING STEPS” on pg. 9.

1 Press the **MENU** button to select the desired Menu setting.

- The Timer function is not available for QUICK, MIXED, and STEAM menu settings.

Ex. When setting Timer 1 to “7:30”.
(Cooking with the WHITE/SUSHI menu setting)

2 Press the **TIMER** button to select “Timer 1” (or “Timer 2”).

- The preset time for “Timer 1” and the START/REHEAT light will blink.
- Press the button again and the preset time for “Timer 2” will appear.

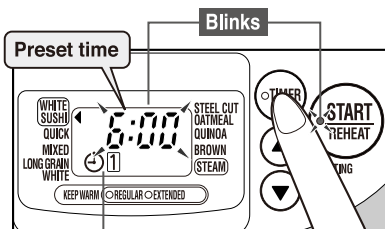

3 Press the **▲** or **▼** button to set a specific time to finish cooking.

▲ : Each press advances the time in 10-minute increments. **▼** : Each press reverses the time in 10-minute increments.

- Press and hold the button to quickly adjust the time in 10-minute increments.
- You do not need to set the time again when using the same settings.

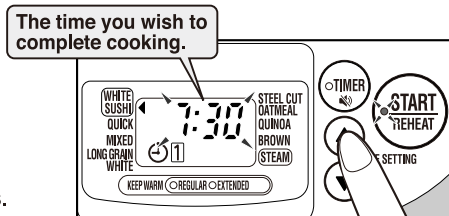

4 Press the **START/REHEAT** button. The melody (beep) sounds, and the Timer setting is complete.

The START/REHEAT light turns off, and the time you wish to finish cooking and the TIMER light turn on.

- The START/REHEAT button must be pressed to set the TIMER.
- Cooking will be completed at the specified time. → See step 6 under “BASIC COOKING STEPS” on pg. 10
- To cancel the Timer setting while using the Timer function, press the CANCEL button.

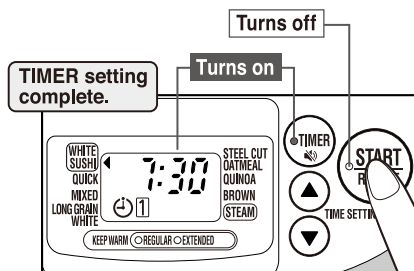

Lengths for the Timer Setting

- Do not set the Timer for 13 hours or more. Furthermore, do not set the Timer for 8 hours or more when the water temperature is high, such as during summer. (This will prevent spoilage caused by rice being soaked for longer than required.)

	1.0 L model	1.8 L model		1.0 L model	1.8 L model
WHITE	1 hour 5 min. –	1 hour 10 min. –	STEEL CUT OATMEAL	1 hour 15 min. –	1 hour 15 min. –
SUSHI	1 hour 5 min. –	1 hour 10 min. –	QUINOA	55 min. –	55 min. –
LONG GRAIN WHITE	1 hour 15 min. –	1 hour 15 min. –	BROWN	1 hour 55 min. –	2 hours –

IMPORTANT

- Do not use the Timer function if you are adding ingredients and/or seasonings to the rice. Ingredients may spoil or seasonings may settle to the bottom of the Inner Cooking Pan and your results may not be satisfactory.

NOTE

- The estimated time until cooking completion will not be displayed when the Timer is set.
- Cooking may not complete at the set time if the temperature of the room or water is too low. In addition, the cooking time may be affected by the amount of water or voltage.
- When cooking using the Timer function, the rice absorbs extra moisture, which can make the rice softer or cause the bran to collect at the bottom and burn.
- If you want to know the current time while using the Timer function, press the **▲** or **▼** button and the Display will switch only while the button is pressed.

HOW TO USE THE STEAM FUNCTION

1 Add water to the Inner Cooking Pan.

18 oz./540 mL (3 cups with the supplied Measuring Cup) for the 1.0 L model
24 oz./720 mL (4 cups with the supplied Measuring Cup) for the 1.8 L model

2 Place the Inner Cooking Pan into the Main Body and place the Steaming Basket.



Wipe the outer surface of the Inner Cooking Pan, the inside of the Main Body, the Inner Lid Set, and the Steam Vent Cap clean of moisture and foreign matter.

- Please make sure to place the Steaming Basket straight, or steam may escape from the gap.

3 Place food in the Steaming Basket from step 2, attach the Inner Lid Set and the Steam Vent Cap, close the Outer Lid, and then insert the Power Plug into an electrical outlet.

- Place food in the Steaming Basket evenly. The Steaming Basket may become slant if the food is heavier on one side.

4 Select the STEAM menu setting by pressing the button.



- When the STEAM menu setting is selected, the default cooking time will appear in the Display. You can make the cooking time longer or shorter by using the  or  buttons. See pg. 18 “Suggested Steaming Time.”

Model	Default Cooking Time	Cooking Time Range
1.0 L model	40 minutes	1 minute – 60 minutes
1.8 L model		

*The cooking time includes the time it takes to boil the water.

5 Press the button.

The START/REHEAT light turns on and the melody (beep) to start steaming will sound. The Display shows the remaining time until steaming completion.

- If you want to know the current time during cooking, press the  or  button and the Display will switch only while the button is pressed.

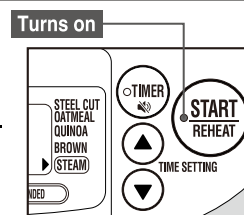

6 When the melody (beep) to indicate cooking completion sounds, press the button and remove the food from the Steaming Basket.

- Remove the food from the Steaming Basket immediately after cooking completion, or the food may become wet or soggy.
- Be careful when opening the Outer Lid and removing the steamed dish and Steaming Basket, as the steam and the inside of the Main Body are very hot.
- Always press the CANCEL button when cooking is complete. The Rice Cooker will beep every 30 minutes as a reminder to remove the food if the CANCEL button is not pressed.
- If the food needs more steaming, restart the process from Step 4 to steam a little longer.
- If smells of food remain inside the Inner Cooking Pan, see pg. 23 “CLEANING AND MAINTENANCE: IF THERE IS AN ODOR” to remove the smell.
- The Steaming Basket may become colored from the ingredients (especially carrots and leafy vegetables), but it will not affect cooking performance. Wash the Steaming Basket immediately after every use as stains will become difficult to remove if they dry out.

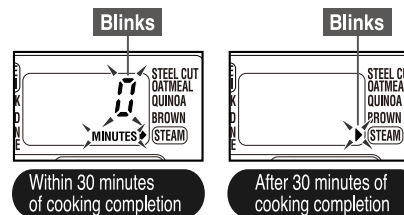

NOTE

- Clean food scum from ingredients such as chicken or fish after cooking.
- Place steamed vegetables in ice water immediately after cooking and then drain them to preserve their bright colors.

Continued on the next page

HOW TO USE THE STEAM FUNCTION (cont.)

Suggested Steaming Time

Ensure that the height does not exceed 1-½"/3.5 cm when the food is added. If this height is exceeded, the food may hit the Inner Lid Set, causing a breakdown.

Ingredients	Amount	Time	Tips for Steaming
Carrot	1, about 7 oz./200 g	20 min.	Cut into bite-size pieces
Broccoli	½, about 7 oz./200 g	15 min.	Cut into bite-size pieces
Spinach	About 3-½ oz./100 g	15 min.	Cut into bite-size pieces
Pumpkin	¼, about 9 oz./250 g	20 min.	Cut into bite-size pieces
Potato	3, about 16 oz./450 g	40 min.	Cut into bite-size pieces
Sweet potato	1, about 10-½ oz./300 g	35 min.	Cut into bite-size pieces
Corn	1, about 7 oz./200 g	30 min.	Cut into bite-size pieces
Chicken	1 fillet, about 10-½ oz./300 g	30 min.	Make cuts on the bottom side (that comes into contact with the Steaming Basket)
Fish (white fish, salmon, etc.)	Cut into fillets, about 5 oz./150 g	25 min.	Slice into less than 1 inch/2 cm thickness and wrap in aluminum foil
Prawn	15, about 5 oz./150 g	20 min.	Steam without removing shells
Scallop	About 5 oz./150 g	20 min.	Remove from shell (It is recommended to line the Steaming Basket with Chinese cabbage or cabbage to prevent the scallops from sticking)
Refrigerated meat dumplings, pot stickers (jiaozi), meat buns (xiaolongbao)	About 7 oz./200 g	15 min.	Leave appropriate space between food items
Frozen meat dumplings, pot stickers (jiaozi), meat buns (xiaolongbao)	About 7 oz./200 g	20 min.	Leave appropriate space between food items

NOTE

Do not cook the following types of foods in the Rice Cooker:

- Thick foods such as curry and stews.
- Foods that may bubble over such as those using baking soda.
- Foods that expand after cooking such as processed seafood products and beans.
- Foods with large amounts of oil.
- Foods packaged in plastic bags.

When cooking...

- Do not use paper towels or other lids to cover the food.
- Remove any foreign matter from the outer surface of the Inner Cooking Pan, Heating Plate or Center Sensor. → **pg. 23-24**
- When using aluminum foil or cooking sheet, do not completely cover the holes on the Steaming Basket, or allow it to extend outside the Steaming Basket. Doing so may cause breakdown, boiling over, or steam may leak.
- Steaming time will vary based on the room and water temperature, voltage, water measurement, size, amount and temperature of the food or other factors.
- If the food is undercooked, repeat the steam process to cook further by following steps **4** through **6**.
- When steaming consecutively, check to make sure there is enough water in the Inner Cooking Pan, and add water accordingly to prevent it from boiling dry.
- Steaming fish and meat for an extended time makes them tough. If they do not cook through, try slicing them thinly before steaming. Adding herbs, garlic or flavoring with salt and pepper may reduce odors.

When cooking other foods together with rice...

- Cook the rice using the **WHITE/SUSHI** menu setting.
- Cook 1 cup of rice if the model has a cooking capacity of 1.0 L and 2 to 4 cups of rice if the model has a cooking capacity of 1.8 L. Cooking too much rice may cause the Outer Lid to open during cooking, preventing the rice from cooking properly and the other ingredients from steaming properly.
- Level the surface of the rice before cooking. → Failure to do so may cause the cooked rice to touch the Steaming Basket.
- Ingredients that require a comparatively long steaming time, such as potatoes, sweet potatoes, corn, pumpkin, and fish (wrapped in aluminum foil) can be cooked together. If they do not cook through properly, reduce the amount of ingredients or cut them into small pieces.
- Ingredients that require a comparatively short steaming time, such as spinach, will not steam properly.
- Do not add ingredients while the rice is cooking.
- The rice may burn more easily or take on the color and odor of the other ingredients.

After cooking...

- Be careful when removing the food as the inside of the Main Body, the Steaming Basket, and the food are extremely hot and can cause burns upon cooking completion.
- Oil and scum may soil the Inner Lid Set and the inside of the Outer Lid, especially when steaming meats. Always wash the Inner Lid Set, Inner Cooking Pan and Steaming Basket after each use, and wipe the Outer Lid Gasket and the inside of the Outer Lid after each use to prevent odors or spoiling.
- Hot condensation may fall from the Inner Lid Set when the Outer Lid is opened and cause burns. Please exercise caution.

RECIPES

The measurements used in these Recipes

■ 1 Tablespoon = 0.5 fl. oz. (15 mL) ■ 1 teaspoon = 0.17 fl. oz. (5 mL)
 ■ Measure the rice with the provided Measuring Cup.
 (1 Cup = approx. 6.1 fl. oz./approx. 180 mL)

HAND-ROLLED SUSHI

Menu Setting: **WHITE/SUSHI**

Ingredients (4-5 servings)

3 cups Rice

* Use the included measuring cup.

Mixed vinegar

4 Tbsp. Rice vinegar

1 Tbsp. Sugar

1 1/2 tsp. Salt

Suggested Toppings

Sashimi (tuna, squid, prawns, etc.)

Japanese pickles (e.g. pickled radish)

Avocado and ham

Natto (fermented soybean) and green onions

Bacon and asparagus

Salmon roe, sea eel and rolled egg

Carrots, cucumbers and celery

Seaweed, *wasabi* (horse radish), soy sauce and pickled red ginger to taste



How to cook

- 1 Clean rice well and fill the Inner Cooking Pan with water to Water Level Line **3** for SUSHI.
- 2 Press the MENU button, select WHITE/SUSHI and press the START/REHEAT button to start cooking.
- 3 When cooking is complete, place the rice into a separate

container (wiped with a clean wet cloth). Pour the mixed vinegar over the rice and mix thoroughly while cooling it with a fan.

- Hand-rolled sushi is simple and quick, wrapping your favorite sashimi, ingredients and sushi rice with *Nori* (seaweed). You can also use a lettuce leaf to wrap your hand-rolled sushi.

CHIRASHI-SUSHI

Menu Setting: **WHITE/SUSHI**

Ingredients (4-5 servings)

3 cups Rice

* Use the included measuring cup.

Mixed vinegar

4 Tbsp. Vinegar

3 Tbsp. Sugar

1 tsp. Salt

1 oz. (28 g) Carrot

1 oz. (28 g) *Gobo*

1 oz. (28 g) Bamboo shoot

2 pieces (38 g) Shiitake mushroom

1 (30 g) *Chikuwa* (a fish paste)

4 fl. oz. (118 mL) Soup stock

2 Tbsp. Sugar

1 Tbsp. Soy sauce

1 Tbsp. *Mirin* (or sake)

2 eggs

1 tsp. *Mirin*

A pinch Salt

Pickled lotus root, *Nori* (Seaweed), Pickled red ginger to taste

Shrimp, Squid, Boiled kidney beans to taste



How to cook

- 1 Clean rice well and fill the Inner Cooking Pan with water to Water Level Line **3** for SUSHI.
- 2 Press the MENU button, select WHITE/SUSHI and press the START/REHEAT button to start cooking.
- 3 When cooking is complete, place the rice into a wooden container (wiped with clean wet cloth). Pour mixed vinegar over the rice and mix thoroughly while cooling it with a fan.

- 4 Cut the carrot into fine pieces, shred *Gobo*, cut the bamboo shoot in small strips, cut shiitake mushrooms in thin strips, and cut the *chikuwa* in lengthwise then cut into small pieces. Boil these ingredients in the soup stock "A" until the soup is gone.

- 5 Mix the ingredients of "B" and fry in a thin crepe, and slice into a small thin strips.

- 6 Mix the ingredients from Step 4 with the Sushi rice from Step 3, sprinkle sliced fried eggs from Step 5, pickled lotus root and *Nori* (seaweed). Decorate with shrimps, squid and kidney beans and top with pickled red ginger.

Continued on the next page

RECIPES (cont.)

MIXED RICE

Menu Setting: **MIXED**

Ingredients (4-5 servings)

3 cups Rice
 * Use the included measuring cup.

<p>2 oz. (57 g) Chicken thigh 1/2 slice (7 g) <i>Age</i> (fried tofu) 1 oz. (28 g) Carrots 1 oz. (28 g) <i>Konnyaku</i> 1 oz. (28 g) <i>Gobo</i> 2-3 (7-11 g) Dried Shiitake mushrooms (soaked in water to constitute)</p>	<p>A { 1 1/2 Tbsp. Light soy sauce 1 1/2 Tbsp. <i>Mirin</i> (sweet sake) 1/2 tsp. Salt 1/2 tsp. <i>Dashinomoto</i></p> <p>Soup taken from soaking dried Shiitake to taste Stone parsley to taste</p>
---	---



How to cook

- 1 Slice chicken thigh into 1/2 inch (1 cm) cubes. Place *Age* in a strainer and pour hot water over it; gently squeeze to drain excess oil, then slice into small strips. Soak chicken thigh and *Age* in soup stock "A" for 5 minutes (do not discard this soup stock).
- 2 Slice carrots and *Konnyaku* into small strips, soak *Konnyaku* in hot water and drain. Shred *Gobo*, soak in water until soft, then drain. Cut Shiitake into small strips.
- 3 Add the soup stock from Step 1 to the water used to soak the dried Shiitake, and mix them well.
- 4 Clean rice and add the mixture from Step 3. Fill the Inner Cooking Pan with water to Water Level Line 3 for MIXED, and

- then mix well from the bottom of the Inner Cooking Pan.
- 5 Place the ingredients from Steps 1 and 2 on top of the rice from Step 4 and spread evenly across the top.
 - Do not mix the ingredients with the rice. Changing the amounts of rice and ingredients may cause imperfect cooking.
 - 6 Press the MENU button, select MIXED and press the START/REHEAT button to start cooking.
 - 7 When the Rice Cooker switches to the Keep Warm mode, mix the rice to loosen it.
 - 8 Serve rice in a bowl and sprinkle stone parsley on top.

CREAMY PARMESAN CHICKEN WITH MUSHROOM RICE

Menu Setting: **LONG GRAIN WHITE**

Ingredients (6-8 servings)

3 cups Long grain white rice
 * Use the included measuring cup.

<p>A { 0.5 oz. (14 g) Thinly sliced dry porcini mushrooms 17 fl oz. (503 mL) Chicken broth 1 Tbsp. Italian seasoning 1 Tbsp. Olive oil</p>	<p>B { 1/2 tsp. Salt 1/2 tsp. Black pepper</p> <p>6 oz. (170 g) Chicken breast cut into bite-size pieces 1 Tbsp. Olive oil</p>
<p>C { 8 oz. (227 g) Thinly sliced mushrooms with ends removed 1/2 tsp. Garlic powder 1/4 tsp. Salt 1/4 tsp. Black pepper</p>	<p>D { 3/4 cup Fresh cream 1/2 cup Parmesan cheese finely grated Salt as needed Black pepper as needed</p> <p>Finely chopped parsley as needed Thin- and rough-chopped parmesan cheese as needed</p>



How to cook

- 1 Combine the ingredients for "A", reconstitute the dry porcini mushrooms for 20 to 30 minutes in the chicken broth. Separate the porcini mushrooms and chicken broth, and strain the broth.
- 2 Wash the long grain white rice, and then drain it in a strainer.
- 3 Put Step 1, the chicken broth from Step 2, the Italian seasoning, and the olive oil into the Inner Cooking Pan; fill with water to

- Water Level Line 3 for LONG GRAIN WHITE; and then mix well from the bottom of the Inner Cooking Pan.
- 4 Rub "B" into the chicken breast. Place this chicken and the reconstituted porcini mushrooms from Step 2 on Step 3 and level the surface.
 - Do not mix the ingredients with the rice. Changing the amounts of rice and ingredients may cause imperfect cooking.
 - 5 Press the MENU button to select LONG GRAIN WHITE.
 - 6 Press the START/REHEAT button.
 - 7 Heat the olive oil in a frying pan, add "C" after mixing the ingredients, and then fry on medium to high heat until the mushrooms are cooked.
 - 8 When rice cooking is complete, add Step 7 and "D", mix well, and then serve.
 - 9 Sprinkle parsley and thin- and rough-chopped parmesan cheese on Step 8.

RECIPES (cont.)

MIXED BROWN RICE

Menu Setting: **BROWN**

Ingredients (4-5 servings)

3 cups Brown rice
 * Use the included measuring cup.
 3 oz. (85 g) Chicken thigh
 1 slice (13 g) *Age* (fried tofu)
 1 oz. (28 g) each Carrots, *Konnyaku* and *Gobo*
 A { 3 Tbsp. Light soy sauce
 | 1/2 Tbsp. *Mirin* (sweet sake)

How to cook

- 1 Slice chicken thigh into 1/2 inch (1 cm) cubes. Place *Age* in a strainer and pour hot water over it; gently squeeze to drain excess oil, then slice into small strips.
- 2 Slice carrots and *Konnyaku* into small strips, soak *Konnyaku* in hot water and drain. Shred *Gobo*, soak in water until soft, then drain.
- 3 Clean rice and put "A" in the Inner Cooking Pan, add water to Water Level Line 3 for BROWN, and then mix well from the bottom of the Inner Cooking Pan.
- 4 Place ingredients from Steps 1 and 2 on top of rice from Step 3.
 - Do not mix the ingredients with the rice. Changing the amounts of rice and ingredients may cause imperfect cooking.
- 5 Press the MENU button, select BROWN and press the START/REHEAT button to start cooking.

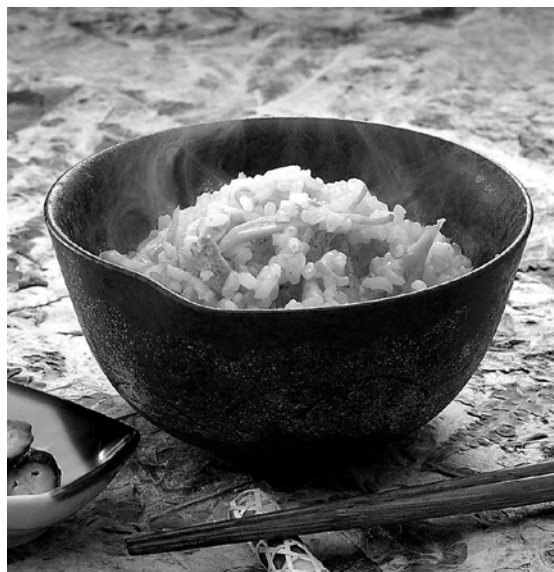

- 6 When the Rice Cooker switches to the Keep Warm mode, mix the rice to loosen it.
 - Clean brown rice lightly to remove husks.
 - When cooking rice with additional ingredients, limit the amount of rice to 1-4 cups for the 1.0 L model and 2-6 cups for 1.8 L model.

BROWN RICE WITH SALMON AND SHIITAKE

Menu Setting: **BROWN**

Ingredients (4-5 servings)

3 cups Brown rice
 * Use the included measuring cup.
 1/4 oz. (7 g) Rehydrated and thinly sliced dried *shiitake* mushrooms
 A { 2 Tbsp. Japanese rice wine
 | 1 1/2 Tbsp. *Mirin* (sweet sake)
 | 2 Tbsp. Soy sauce
 | 1/4 tsp. Salt
 Soup taken from soaking dried *shiitake* mushrooms as needed
 6 oz. (170 g) Raw salmon with bones and skin removed
 Stone parsley as needed

How to cook

- 1 Clean the brown rice well, add "A" and the soup taken from soaking dried *shiitake* mushrooms, pour water to Water Level Line 3 for BROWN, and then mix well from the bottom of the Inner Cooking Pan.
- 2 Place the raw salmon and the *shiitake* mushrooms on top of the ingredients from Step 1 and level the surface.
 - Do not mix the ingredients with the rice. Changing the amounts of rice and ingredients may cause imperfect cooking.



- 3 Press the MENU button, select BROWN and press the START/REHEAT button to start cooking.
- 4 When cooking is complete, mix the dish to loosen it, and then serve the dish in bowls and garnish with stone parsley.

Continued on the next page

RECIPES (cont.)

BLACK BEANS AND SWEET CORN QUINOA

Menu Setting: **QUINOA**

Ingredients (2-4 servings)

2 cups Quinoa

* Use the included measuring cup.

- A**
- 1 Tbsp. Olive oil
 - 1 Tbsp. Chili powder
 - 1/2 tsp. Salt
 - 1/2 tsp. Black pepper
 - 1 tsp. Garlic powder
 - 1 tsp. Cumin powder

9 fl oz. (266 mL) Vegetable broth (to Water Level Line 2)

- B**
- 2/3 (73 g) Medium-sized onion finely chopped
 - 1/4 (30 g) Medium-sized red paprika finely chopped
 - 1/2 (20 g) Medium-sized celery finely chopped
- C**
- 1 cup (160 g) Drained sweet corn (kernels; canned; net weight)
 - 1 cup (168 g) Washed and drained black beans (canned)
 - 2 tsp. Jalapeño finely chopped
 - 1 (123 g) Medium-sized tomato chopped into small pieces
 - 2/3 cup (18 g) Cilantro roughly chopped
 - 1 1/2 Tbsp. Lime juice
 - Salt as needed

How to cook

- 1 Rinse the quinoa and drain it in a fine strainer or something similar and add it to the inner cooking pan.
- 2 Mix the ingredients in "A" into Step 1. Fill with vegetable broth to Water Level Line 2 for QUINOA and mix well from the bottom of the Inner Cooking Pan.



3 Place "B" on Step 2 and level the surface.

- Do not mix the ingredients with the quinoa. Changing the amounts of quinoa and ingredients may cause imperfect cooking.
- 4 Press the MENU button to select QUINOA.
 - 5 Press the START/REHEAT button.
 - 6 When cooking is complete, add "C", mix well, and then serve.

CARROT CAKE STEEL CUT OATMEAL

Menu Setting: **STEEL CUT OATMEAL**

Ingredients (2-4 servings)

2 cups Steel cut oatmeal

* Use the included measuring cup.

1/4 tsp. Salt

- A**
- 1 1/2 tsp. Pumpkin pie spice (or cinnamon powder)
 - 9 fl oz. (266 mL) Coconut milk (canned) mixed well if hardened
 - 1/3 cup Honey
 - 1 tsp. Vanilla essence
- B**
- 1 cup (95 g) Carrot shredded
 - 2 Tbsp. Dry pineapple finely chopped
 - 2 Tbsp. Walnuts chopped
- 1/4 tsp. Pumpkin pie spice (or cinnamon powder)
- Dry apricot (cut into cubes) to taste
- Dry pineapple (cut into cubes) to taste
- Sliced almonds (baked lightly) to taste
- Coconut flakes (baked lightly) to taste
- Cinnamon sticks to taste

How to cook

- 1 Put "A" into the Inner Cooking Pan, fill with water to Water Level Line 2 for STEEL CUT OATMEAL, and then mix well from the bottom of the Inner Cooking Pan.
- 2 Place "B" on Step 1 and level the surface.
 - Do not mix the ingredients with the steel cut oatmeal. Changing the amounts of steel cut oatmeal and ingredients may cause imperfect cooking.



3 Press the MENU button to select STEEL CUT OATMEAL.

- 4 Press the START/REHEAT button.
- 5 When cooking is complete, mix well, and then serve. Coat evenly with pumpkin pie spice; sprinkle dry apricot, dry pineapple, sliced almonds, and coconut flakes to taste; and then garnish with cinnamon sticks.

CLEANING AND MAINTENANCE

- Clean the Rice Cooker thoroughly after every use.

IMPORTANT

- Be sure to unplug the Power Cord and allow the Main Body and the Inner Cooking Pan to cool down before cleaning.
- Do not use such items as thinner, abrasive cleaners, bleach, alcohol disinfectant, scrubbing brushes (nylon, metal, etc.), melamine sponges or sponges with a nylon surface. (Doing so may damage the surface, causing discoloration, scratches, degradation in quality, or corrosion.)
- Do not use a dishwasher or dish-dryer. Doing so may cause scratches, deformation or discoloration.
- Be sure to reattach the Inner Lid Set, Steam Vent Cap, and Spatula Holder correctly.



THE EXTERIOR

Wipe clean with a well-wrung soft cloth.

- If using a cloth that is chemically treated, use sparingly to avoid transferring the chemical smell and do not scrub the Rice Cooker forcefully. (Doing so may damage the surface, causing discoloration, scratches, degradation in quality, or corrosion.)

Open Button

If the Open Button becomes clogged with rice or other matter, remove with a bamboo skewer.

- Otherwise the Outer Lid may not open.

Air Vent

Clean using a vacuum cleaner (once a month).

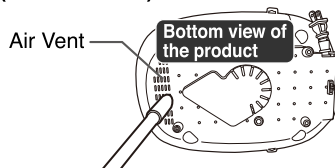

- If you use the Rice Cooker while there is dust or other matter stuck to the Air Vent, the internal temperature may become abnormally high, resulting in breakdown.

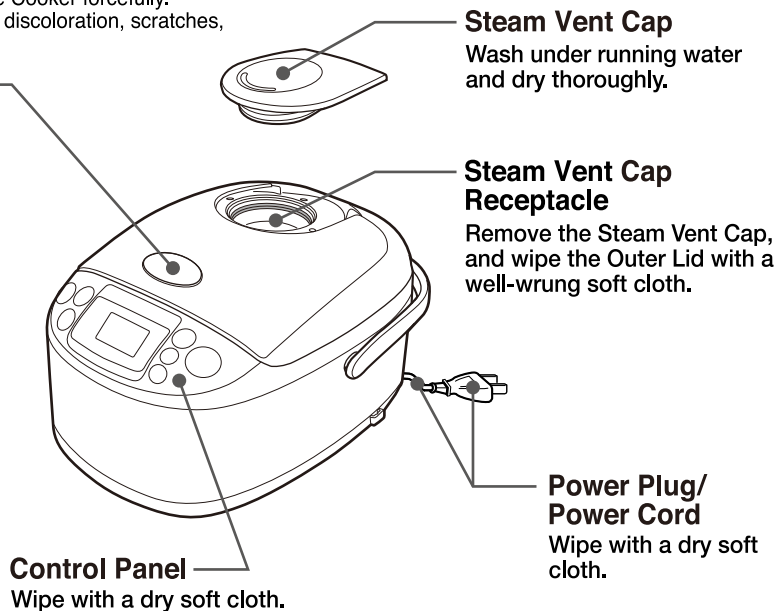

Steam Vent Cap

Wash under running water and dry thoroughly.

Steam Vent Cap Receptacle

Remove the Steam Vent Cap, and wipe the Outer Lid with a well-wrung soft cloth.

Control Panel
Wipe with a dry soft cloth.

Power Plug/Power Cord
Wipe with a dry soft cloth.

Inner Cooking Pan (→ pg. 6)/Spatula/Steaming Basket

Wash using a neutral kitchen detergent and a soft sponge.



The Nonstick Coating on the inner surface of the Inner Cooking Pan can peel off if damaged, so follow the precautions listed below.

- Do not use polishing powder, metal or nylon scrubbing brushes.
- Handle gently. Do not strike it or rub it too hard.
- When dry rice or other food has stuck to the Inner Cooking Pan or Spatula, soak it in water until the food softens, and then wash this item off with a soft sponge or something similar.

Measuring Cup/Spatula Holder

Wash using a soft sponge.

- To wash thoroughly, use a neutral kitchen detergent.



IF THERE IS AN ODOR

- 1 Fill the Inner Cooking Pan with water up to Water Level Line 1 for WHITE for 1.0 L model, and Water Level Line 2 for 1.8 L model.
 - Do not put other matter such as kitchen detergents in the Inner Cooking Pan.
- 2 Close the Outer Lid and press the **MENU** button to select the QUICK menu setting.
- 3 Press the **START/REHEAT** button.
- 4 When a melody (beep) sounds and the Rice Cooker switches to the Keep Warm mode, press the **CANCEL** button.
- 5 Wait until the Main Body cools down, discard the water and clean accordingly.
 - Open the Outer Lid and dry the Rice Cooker in a well ventilated place.

Continued on the next page

CLEANING AND MAINTENANCE (cont.)

THE INTERIOR

Outer Lid Gasket

Wipe with a well-wrung soft cloth. Remove any rice or residue.

- The Outer Lid Gasket cannot be removed.

Inner Lid Set

Rinse in hot or cold water, wash using a soft sponge, and dry thoroughly.

- Do not remove the Inner Lid Knob.
- Be sure to clean the Inner Lid Set after every use. If left dirty or wet, the color may change to brown or rust may form.

Center Sensor

Wipe with a well-wrung soft cloth. If it becomes clogged with rice or other matter, remove with a bamboo stick.

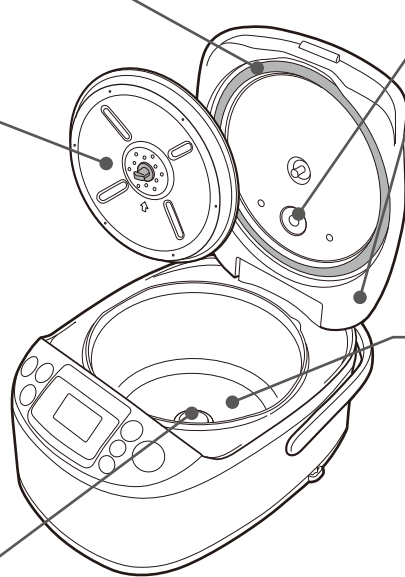

Outer Lid / Steam Vent

Hold the Outer Lid securely and wipe with a well-wrung soft cloth. Remove any rice or residue on the inside of the Outer Lid.

- Leaving rice, other matter or moisture on the surface may cause the Outer Lid to rust or discolor.

Heating Plate

Wipe the surface with a well-wrung soft cloth.

If rice or other matter becomes stuck to the Heating Plate, lightly polish it off with a sandpaper of about No. 320 after dipping in water.

If it becomes clogged with rice or other matter, remove with a bamboo stick.

HOW TO DETACH AND ATTACH THE INNER LID SET

HOW TO DETACH

Hold the Outer Lid with one hand and pull the Inner Lid Knob toward you with the other hand.

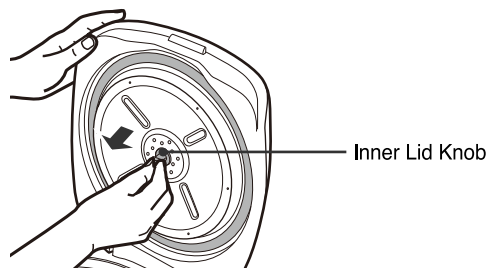

HOW TO ATTACH

Affix the hollow part of the Inner Lid Set (rear of the Inner Lid Knob) to the Inner Lid Set Mounting Axis to attach the Inner Lid Set.

Rear of the Inner Lid Knob

Affix this hollow part to the Inner Lid Set Mounting Axis.

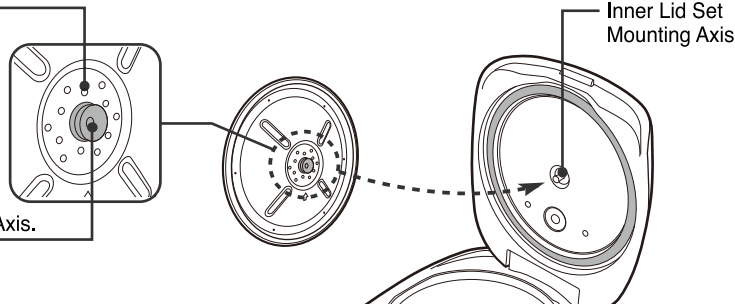

TROUBLESHOOTING GUIDE

● Please check the following points before calling for service.

Problems	Possible Causes/Solutions
COOKING RICE Rice cooks too hard or too soft Rice is scorched The surface of the cooked rice is uneven Boils over while cooking Unable to start cooking or the buttons do not respond Steam comes out from the gap between the Outer Lid and the Main Body	<ul style="list-style-type: none"> ● Increase or decrease water slightly (by 1-2 mm) from the Water Level Line according to your preference. ● If the amount of water is adjusted with the Rice Cooker on a tilted surface, the amount of water may be too high or too low, which will lead to changes in the hardness of the cooked rice. ● The texture of rice varies depending on the brand of the rice, where it was harvested, and how long it was stored (new crop or old crop). ● The texture of rice varies depending on the room and water temperatures. ● Using the Timer may result in softer rice. ● Using the QUICK menu setting may result in harder or wet rice. → Please try using the WHITE/SUSHI menu setting. ● Make sure the Inner Cooking Pan is not deformed. ● Rice may not have been cleaned sufficiently, leaving too much bran on the rice. ● Did you level the surface of the rice before cooking? ● Did you loosen the rice after cooking was completed? → Loosen the rice immediately after cooking is completed. ● Is there moisture or foreign matter such as (cooked or uncooked) rice on the bottom of the Inner Cooking Pan, the Center Sensor, or the Heating Plate? → Wipe them off. ● Is there moisture or foreign matter on the inside of the Main Body, the Inner Lid Set, or the Steam Vent Cap? → Wipe them off. ● Long Grain White Rice may be slightly harder than Short or Medium Grain Rice. → To make it softer, fill the water slightly higher than the Water Level Line on the Inner Cooking Pan (to a point within half the distance to the next Water Level Line) and cook. However, please note that adding too much water may cause it to boil over.
	<ul style="list-style-type: none"> ● Is there moisture or foreign matter such as (cooked or uncooked) rice on the bottom of the Inner Cooking Pan, the Center Sensor, or the Heating Plate? → Wipe them off. ● If you soak the rice for a long time or cook rice using the Timer, the bran may collect at the bottom, and the rice will be more easily scorched. ● Rice may not have been cleaned sufficiently, leaving too much bran on the rice. ● Make sure the Inner Cooking Pan is not deformed.
	<ul style="list-style-type: none"> ● Depending on the heat convection while cooking, the surface of the cooked rice may look uneven. ● Did you level the surface of the rice before cooking? ● Make sure the Inner Lid Set and the Inner Cooking Pan are not deformed.
	<ul style="list-style-type: none"> ● Did you use the wrong Menu setting or amount of water? → pg. 11 When cooking using the STEEL CUT OATMEAL or QUINOA menu setting, the contents are particularly likely to boil over, so be sure not to use the wrong amount of water. → See “Be careful that the contents do not boil over.” on pg. 10 ● Make sure the Steam Vent Cap is attached. ● Rice may not have been cleaned sufficiently, leaving too much bran on the rice. ● Make sure the Inner Cooking Pan is not deformed.
	<ul style="list-style-type: none"> ● Make sure the Power Plug is plugged in securely. ● Does the Display show “E01” or “E02” ? → pg. 28 ● Is the KEEP WARM light on? → Press the CANCEL button and press the START/REHEAT button. ● Is “0” blinking on the Display? → Press the CANCEL button, and then perform other operations. ● Did you press the START/REHEAT button after selecting a menu setting on the display panel? → The START/REHEAT button must be pressed to start cooking the rice.
	<ul style="list-style-type: none"> ● Make sure that the Inner Lid Set has not been dropped or deformed, and that the Outer Lid Gasket is not torn. ● Has the Outer Lid Gasket become soiled? → Clean the Outer Lid Gasket. ● Make sure the Inner Cooking Pan is not deformed.
COOKING RICE/ KEEP WARM A noise is heard during Cooking/ Keep Warm The Reheat function does not work	<ul style="list-style-type: none"> ● The microprocessor (MICOM) makes a sound while adjusting the heat power of the Rice Cooker. This does not indicate a problem. ● There is a spark-like noise when there is water left on the outside of the Inner Cooking Pan. → Always take precautions to wipe the outer surface of the Inner Cooking Pan and the inside of the Main Body clean, especially of moisture and foreign matters, before placing the Inner Cooking Pan into the Main Body.
	<ul style="list-style-type: none"> ● Make sure the KEEP WARM light is not off. → pg. 15

Continued on the next page

TROUBLESHOOTING GUIDE (cont.)

Problems	Possible Causes/Solutions
<p style="text-align: center;">KEEP WARM</p>	<ul style="list-style-type: none"> ● Was the rice kept warm with the Spatula left in the Inner Cooking Pan? ● Was cold rice reheated? ● Did you loosen the rice after cooking was completed? → Loosen the rice immediately after cooking is completed. ● Rice may not have been cleaned sufficiently, leaving too much bran on the rice. ● Some odor may remain after cooking mixed rice or after using the STEAM menu. → Clean the Inner Cooking Pan thoroughly and perform “IF THERE IS AN ODOR” on pg. 23 ● The Keep Warm mode may not have been used for keeping rice warm. → Leaving rice in the Inner Cooking Pan without using the Keep Warm mode may cause unwanted odor. → pg. 7 ● Did you clean the Rice Cooker thoroughly after every use? → Foul odors due to the growth of bacteria may occur depending on how well the unit is cleaned, the room temperature based on the season or usage environment, frequent opening and closing of the Outer Lid, the type of rice used, or the way the rice was cleaned. If you are concerned about odors, cleaning the Rice Cooker according to “THE INTERIOR” on pg. 24 and then using REGULAR KEEP WARM on pg. 13 should be effective. It can be even more effective to increase the Keep Warm temperature, as described on pg. 28, “IF THE FOLLOWING OCCURS” .
	<ul style="list-style-type: none"> ● Is there moisture or foreign matter such as (cooked or uncooked) rice on the bottom of the Inner Cooking Pan, the Center Sensor, or the Heating Plate? → Wipe them off. ● Are you keeping warm a small amount of rice in the Inner Cooking Pan? ● Was the Keep Warm mode used for more than 12 hours? → pg. 13 ● Certain types of rice and water used may make the rice appear yellow. ● If you are concerned about the rice becoming yellow or dry, see pg. 28 “IF THE FOLLOWING OCCURS”. It may be effective to reduce the Keep Warm temperature.
	<ul style="list-style-type: none"> ● Does the Display show the current time? → Press the Time Setting buttons to change the display. → pg. 14 “NOTE” .
	<ul style="list-style-type: none"> ● Did you select a menu setting for which the Extended Keep Warm mode is not available? → pg. 13 ● Was the Keep Warm mode used for more than 12 hours? → If the Keep Warm mode is used for more than 12 hours, the Extended Keep Warm mode will not be accepted. ● Is the rice in the Inner Cooking Pan cold? → If the temperature of the Inner Cooking Pan is low, the Extended Keep Warm mode will not be accepted.
	<ul style="list-style-type: none"> ● If the temperature of the rice is low, or if the Keep Warm time has exceeded 12 hours, the Keep Warm elapsed time display will blink. (This may differ depending on the Menu setting.) → pg. 13
<p style="text-align: center;">TIMER COOKING</p>	<ul style="list-style-type: none"> ● Is the current time set correctly? → The clock is displayed in 24-hour (military) time. Please check and set it again. ● If the Timer is set to a time that is less than the timer cooking times, the Rice Cooker will begin cooking immediately.
	<ul style="list-style-type: none"> ● Is the current time set correctly? → The clock is displayed in 24-hour (military) time. Please check and set it again. ● Cooking may not complete at the set time if the temperature of the room or water is too low. In addition, the cooking time may be affected by the amount of water or voltage.
	<ul style="list-style-type: none"> ● Did you press the START/REHEAT button after setting the time? → The START/REHEAT button must be pressed to complete setting the Timer. ● Is “7:00” blinking on the Display? → Unless the current time is set, the Timer function will not be accepted. → pg. 8 ● Have you selected a Menu setting that doesn’t work with the Timer function? → The Timer function is not available for QUICK, MIXED, and STEAM menu settings.

TROUBLESHOOTING GUIDE (cont.)

Problems	Possible Causes/Solutions	
STEAM COOKING	<p>Food does not steam</p>	<ul style="list-style-type: none"> ● Is there sufficient water for steaming? → pg. 17 ● Are there too many ingredients? → Reduce the amount of ingredients, or increase cooking time. ● Are the ingredients too large? → Cut ingredients into smaller sizes, or increase cooking time. → pg. 18 “Estimated Steaming Time”
	<p>Steamed food is hard</p>	<ul style="list-style-type: none"> ● Vegetables: Steaming time is too short. Add more water and continue steaming. ● Fish and meat: Steaming time is too long. Reduce the steaming time.
	<p>Steamed food is cold</p>	<ul style="list-style-type: none"> ● Has too much time elapsed since cooking was completed? → Do not leave on Keep Warm. Take out the ingredients immediately after cooking.
OTHER	<p>The Outer Lid cannot be opened</p>	<ul style="list-style-type: none"> ● If you press the edge of the Open Button, the Outer Lid may be difficult to open. Be sure to press the center of the Open Button.
	<p>The Outer Lid won't close</p>	<ul style="list-style-type: none"> ● Is the Inner Lid Set attached correctly?
	<p>The Outer Lid opens during cooking</p>	<ul style="list-style-type: none"> ● Did you close the Outer Lid completely? → Be sure to close the Outer Lid until you hear it click shut.
	<p>You mistakenly put rice and water directly into the Main Body</p>	<ul style="list-style-type: none"> ● Putting rice and water directly into the Main Body may cause a malfunction. Contact the store where you purchased the Rice Cooker or Zojirushi Customer Service.
	<p>There's a resinous odor, such as that of plastic</p>	<ul style="list-style-type: none"> ● When you use this Rice Cooker for the first time, there will be a resinous smell, such as that of plastic, but the odor will lessen as you use the Rice Cooker. If you are concerned about the odor, please see pg. 23 “IF THERE IS AN ODOR” .
	<p>When power failure occurs</p>	<ul style="list-style-type: none"> ● If too many appliances are used simultaneously, an overload may occur and the breaker will cut off the electricity. → If another appliance is plugged into the same outlet as the Rice Cooker, unplug it before resetting the breaker. If the electric supply recovers within 10 minutes, the Rice Cooker will resume cooking automatically.
	<p>The estimated time until cooking completion is not displayed</p>	<ul style="list-style-type: none"> ● If cooking is performed consecutively, the estimated time will not be displayed until the Main Body cools down, but the rice cooking will start. This is not a malfunction.
	<p>There is rust colored dirt on the inside of the Outer Lid or the Inner Lid Set</p>	<ul style="list-style-type: none"> ● If rice residue is stuck on the Outer Lid or the Inner Lid Set and has discolored, clean it. → pg. 24
<p>The button operation sound is not generated</p>	<ul style="list-style-type: none"> ● Is the sound muted? → Change the Notification Sound setting. → See “HOW TO CHANGE THE NOTIFICATION SOUND” on pg. 8. 	

IF THE FOLLOWING OCCURS

When you are concerned about foul odors, color changes or dryness in the rice...

Change the Keep Warm temperature.

Depending on the region or environment, the Keep Warm temperature may lower, and this can cause foul odors in the rice. If the Keep Warm temperature rises, this can cause the rice to change color or become dry. If the rice smells, changes color or becomes dry, try changing the Keep Warm temperature settings as follows.

- REGULAR KEEP WARM and EXTENDED KEEP WARM will change at the same time.

How to Change the Keep Warm Temperature Settings

- 1 Set the Inner Cooking Pan and insert the Power Plug into an electrical outlet.

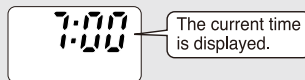

- 2 Press and hold the **CANCEL** button for 3 seconds or longer.

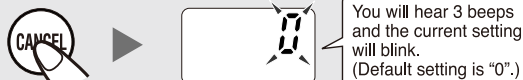

- 3 Press the **▲** or **▼** to set the temperature.

If you press the **▲**, the setting changes in the direction of the **→**. If you press the **▼**, the setting changes in the direction of the **←**.

If you are worried about odors in the rice, select [1] – [3] to increase the Keep Warm temperature.

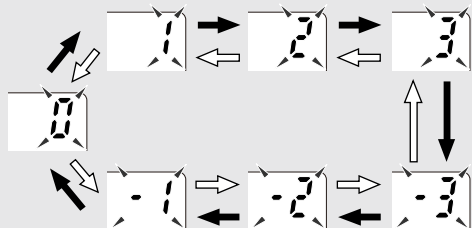

If you are worried about changes in color or dryness in the rice, select [-1] – [-3] to decrease the Keep Warm temperature.

- 4 Press the **MENU** button.

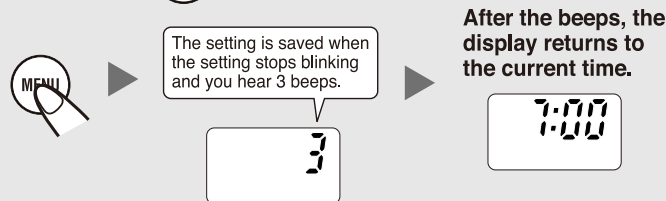

NOTE

- Settings cannot be changed during Cooking (steaming), Reheating, Regular Keep Warm, Extended Keep Warm or Timer Cooking.
- If you are unable to successfully complete the operation the first time, start again from Step 1.
- Once you change the setting, that setting will be saved even if you unplug the Power Plug from the electrical outlet.
- If 15 seconds or more elapse without any action while you are changing the setting, the display will revert to the current time and the setting will not be changed.

If there is no improvement after you change the Keep Warm temperature setting, return it to the original setting, as the changed setting may cause odors, color changes or dryness.

ERROR DISPLAYS AND THEIR MEANINGS

If the countermeasures listed below do not solve the problem, contact the store where you purchased the Rice Cooker or Zojirushi Customer Service.

Panel Display	Cause (Points to check)
	<ul style="list-style-type: none"> ● The temperature of the Lid Sensor or the Center Sensor is too high. → Press the CANCEL button and open the Outer Lid for more than 45 minutes and allow the interior to cool down. (Be careful not to burn yourself.) To cool faster, see pg. 10.
	<ul style="list-style-type: none"> ● Is the Power Plug unplugged from the electrical outlet? → The Display turns off when the Power Plug is not connected.
Error Display When the Power Cord is plugged in, is blinking	<ul style="list-style-type: none"> ● If the Display shows a blinking 7:00, reset the time. → pg. 8 Once the clock is set, the Rice Cooker will function normally. If rice is cooked while the Display shows a blinking 7:00 (when the clock has not been set), the current time will not be shown during the cooking process or during Keep Warm. ● When the Display shows a blinking 7:00 even after unplugging the Power Plug from and plugging the Power Plug back into the electrical outlet When the lithium battery is dead, stored memories (current time, menu selection, and Keep Warm settings) will be erased if the Power Plug is unplugged from the electrical outlet. However, if the Power Plug is plugged back into the electrical outlet and the clock is set, the Rice Cooker will function normally. Contact Zojirushi Customer Service to have the lithium battery replaced (a fee will be charged for the replacement).
Odd Display	<ul style="list-style-type: none"> ● Unplug the Power Cord and plug it in again.
	<ul style="list-style-type: none"> ● Indicates malfunction. → Please contact the store where you purchased the Rice Cooker or Zojirushi Customer Service.

REPLACEMENT PARTS

- Please replace damaged parts for optimum performance.
- When replacing parts, please check the model number and the parts name beforehand, then contact the store where you purchased the Rice Cooker or Zojirushi Customer Service.

Zojirushi Customer Service
1-800-733-6270
www.zojirushi.com

Part Name		Part Number
Inner Lid Set	1.0 L model	C194-6B
	1.8 L model	C243-6B
Inner Cooking Pan	1.0 L model	B625-6B
	1.8 L model	B626-6B
Spatula		SHAKN-6B
Spatula Holder		616864-00
Measuring Cup		615784-00
Steaming Basket	1.0 L model	BU195031L-00
	1.8 L model	BU195032L-00

SPECIFICATIONS

Model No.		NS-TSC10A	NS-TSC18A
Cooking Capacity (approx. L) [cups] *1	WHITE (Short/Medium grain white rice)	0.18–1.0 [1–5.5]	0.36–1.8 [2–10]
	SUSHI (Short/Medium grain white rice)	0.18–1.0 [1–5.5]	0.36–1.8 [2–10]
	QUICK (Short/Medium grain white rice)	0.18–1.0 [1–5.5]	0.36–1.8 [2–10]
	MIXED (Short/Medium grain white rice)	0.18–0.72 [1–4]	0.36–1.08 [2–6]
	LONG GRAIN WHITE (Long grain white rice)	0.18–1.0 [1–5.5]	0.36–1.8 [2–10]
	STEEL CUT OATMEAL	0.18–0.45 [1–2.5]	0.36–0.54 [2–3]
	QUINOA	0.18–0.72 [1–4]	0.36–1.08 [2–6]
	BROWN (Short/Medium grain brown rice)	0.18–0.72 [1–4]	0.36–1.44 [2–8]
Height Limit for Steamed Foods		1-½ inch/3.5 cm	
Rating		AC 120 V 60 Hz	
Electric Consumption		610 W	820 W
Average Power Consumption during Keep Warm		29 W	35 W
Rice Cooking System		Direct Heating	
Power Cord Length		3' 7" (1.1 m)	
External Dimensions	<approx. inch>	10-1/8 (W) × 14 (D) × 8-5/8 (H) (16-1/4 *2)	11-1/8 (W) × 15 (D) × 10 (H) (18-5/8 *2)
	<approx. cm>	25.5 (W) × 35.5 (D) × 21.5 (H) (41 *2)	28 (W) × 38 (D) × 25 (H) (47 *2)
Weight		approx. 8 lbs. (approx. 3.5 kg)	approx. 11 lbs. (approx. 4.6 kg)

- The average power consumption during Keep Warm is calculated with the Rice Cooker at maximum capacity and at a room temperature of 68°F (20°C).
- This product may not operate properly in certain environments or places with high altitudes or extreme weather conditions. Please avoid using this product in such areas.
- This product cannot be used in areas where power supply voltage or power supply frequency is different.
- (*1) Capacity is measured in the supplied rice measuring cup, using uncooked rice. Other grains may vary.
- (*2) Height with the Outer Lid open.



www.zojirushi.com

FOR CALIFORNIA USA ONLY

This product contains a CR Coin Lithium Battery which contains Perchlorate Material - special handling may apply. See www.dtsc.ca.gov/hazardouswaste/perchlorate

NS-TSC-A ©(B)(A)